

VERIFIER

Speech Intelligibility instrument



Owner's Manual



Copyright

This document is copyrighted by Quest Technologies, Inc. Permission is hereby granted to copy and distribute this manual provided that this Copyright Page is included. This grant does not include permission to modify the manual's text or illustrations in any way.

This manual may not be translated without obtaining permission in advance.

Trademarks

Quest Technologies and the Quest logo and QuestSuite® Professional II are registered trademarks of Quest Technologies Incorporated. All rights are reserved.

Microsoft, Microsoft Excel, and Windows are registered trademarks of Microsoft, Inc.

Updates

In the interests of continuous product improvements, Quest Technologies reserves the right to make changes to product specifications without notice. To understand the latest updates that have been implemented into this product and to download the most current version of this user manual, visit our web site at www.quest-technologies.com.

Copyright © 2010 Quest Technologies, a 3M company

Table of Contents

CHAPTER 1: Introduction	1
Mass notification system (MNS)	1
Factors with speech intelligibility	2
Measurements	2
Speech transmission index (STI)	2
STI scale or CIS scale explained	3
Speech intelligibility scale (STI)	3
Common intelligibility scale (CIS)	3
Zones	4
When to take STI-PA measurements	4
CHAPTER 2: Getting Started	5
Checking the equipment	5
Microphone and accessories	6
Windscreen	6
Attaching the preamp and microphone	7
Display and Keypad	8
Explained	8
Quick Start	9
Turning on	9
Start screen	10
Navigating	10
Turning off	11
Screen indicators explained	11
Providing power	12
Installing batteries	12
Battery power explained	13
Checking type	13
Power supply or auto adapter	14
Connector panel/ hardware	15
Memory card slot	15
USB port	15
AC/DC port	15
Power jack	16
Auxiliary port	16
CHAPTER 3: Setting-up the Verifier	17
Measures setup screen and capturing background noise	17
Setting up time and date	20
Setting up the display (language, backlight, and contrast)	21
Changing microphone settings	22
Unit information screen	23
CHAPTER 4: Calibrating and Communication	25
Calibrate	25
Calibration screen	25
Pre-calibration	25
Post-calibration	26
Attaching the calibrator to the Verifier	26
Communications	28
USB communications	29
GPS	29

GPS display	30
GPS explained	30
CHAPTER 5: Measuring and reviewing results	33
Guideline to setting up a STI-PA test	33
About STI-PA measurements & modulation screen results	34
Conducting a level setup	35
Preparing to measure	35
Running a speech intelligibility study	36
Captured curves (storing background noise)	38
Applying captured curves (background noise)	38
Reviewing results	40
File directories	40
File directory screen explained	40
Differences between directories	41
Loading and deleting files	41
Viewing past measurements	42
Memory card	43
Compatibility	43
Formatting card	43
Naming and renaming files	43
Renaming session files	43
Naming	44
Configuration file	45
Creating	45
Viewing results in Excel and file converter tool	46
Downloading the SES file Translator	46
Exporting from the Verifier to your PC	47
APPENDIX A: Specifications	51
APPENDIX B: Glossary of terms	59
APPENDIX C: Contacting customer service	64
INDEX	66

Figures

Figure 1-1:	Testing a MNS & factors influencing the site	1
Figure 1-2:	STI scale	3
Figure 1-3:	CIS scale	3
Figure 2-1:	Verifier equipment	5
Figure 2-2:	Verifier, preamp and microphone	7
Figure 2-3:	Verifier keypad and display explained	8
Figure 2-4:	Verifier start screen	10
Figure 2-5:	Arrows and enter keys on the keypad	10
Figure 2-6:	Installing batteries	12
Figure 2-7:	Battery check screen	13
Figure 2-8:	Selecting battery type in battery check screen	14
Figure 2-9:	Power supply adapter examples	14
Figure 2-10:	Connector panel	15
Figure 3-1:	Sample measures setup screen	17
Figure 3-1:	Setup screen	18
Figure 3-2:	Speech intelligibility/measures setup screen	19
Figure 3-3:	Setting up time and date	20
Figure 3-4:	Display screen (language, backlight, and contrast)	21
Figure 3-7:	Unit information screen	24
Figure 4-1:	Attaching calibrator to the Verifier	26
Figure 4-2:	Calibrating the Verifier	27
Figure 4-3:	Pre-calibrate history screen	27
Figure 4-4:	Post-calibrate history screen	28
Figure 4-5:	QSPII/Serial and mass storage screens	29
Figure 4-6:	GPS data	30
Figure 5-1:	Level set-up and average decibel level	35
Figure 5-2:	STI-PA results screen	37
Figure 5-3:	Modulation screen with STI-PA results	37
Figure 5-4:	Saving capture curve/background noise	38
Figure 5-5:	Selecting a captured curve/background noise	39
Figure 5-6:	File directory screen	40
Figure 5-7:	Examples of directory screens	41
Figure 5-8:	Loading and deleting files	42
Figure 5-9:	Viewing files	44
Figure 5-10:	Example of explorer pop-up window with SES files	47
Figure 5-11:	Example of sound level meter studies	48
Figure 5-12:	Verifier SES translator export dialogue box	48
Figure 5-13:	Example session summary data in Excel	49
Figure 5-14:	Example study data in Excel	49

Introduction

The Verifier simplifies the methodology used to measure and report Speech Intelligibility results. This manual provides a brief overview of basic sound principles, range of speech, and components used to measure speech comprehension.

This chapter will provide a quick overview of how to set-up, when to conduct, and what scale to apply for your Speech Intelligibility testing.

Mass Notification System (MNS)

A mass notification system (MNS) is a type of alarm used to inform occupants in the event of an emergency. For example, an emergency message at an airport or sports arena may be difficult to understand with background noise and reverberation of speech through the speaker system. In order to be effective, the system must have clear and audible instructions.

With the Speech Intelligibility instrument, you have the capability to conduct a sound level test programmed with either Speech Transmission Index scale (STI scale) or Common Index Scale (CIS scale) enabled to determine if the system is *intelligible*.

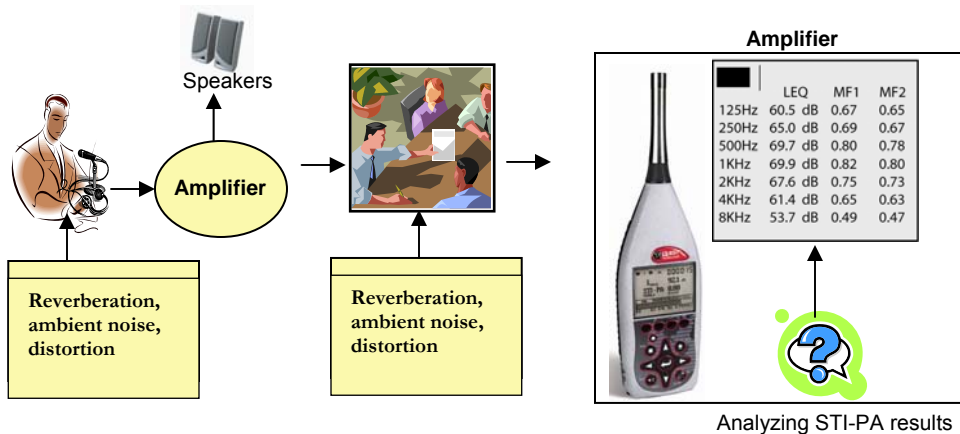

Figure 1-1: Testing a MNS & factors influencing the site

Factors with Speech Intelligibility

There are various factors which affect the transmission of speech from an alarm system to occupants. These factors have been defined by NFPA-72 code (National Fire Alarm Code) as the following: distortion, echoes, reverberation, level of ambient noise, and announcements signal-to-noise ratio.

Measurements

The Verifier STI-PA meter (speech transmission index – public address) determines the intelligibility, or quality of sound, in a building/environment by measuring the system on a Speech Transmission Index (STI) scale or a Common Intelligibility Scale (CIS).



Speech Transmission Index (STI)

Speech Transmission Index (STI) is a standard index, developed in 1970's, used to evaluate and classify speech intelligibility dependent of background noise level. STI is the standardized measurement in the IEC 60268-16:1998 standard.

STI refers to the amount of modulation preserved in the broadcasting of an artificial speech signal through an alarm system. The intelligibility measurement is a single value between zero and one, which factors in corruption of speech, with modulating speech frequencies over octave bands between 125Hz to 8kHz.

STI-PA is measured using seven octave bands and 12 modulation indices per octave band simultaneously allowing a 15 second measurement. In essence, any noise which masks (or corrupts) the talker-to-listener path is evaluated and a recommended measurement is computed at the end of an intelligibility test. The following sections briefly address points to consider when setting up a STI-PA test.

3 | Factors with Speech Intelligibility *STI scale or CIS scale explained*

STI scale or CIS scale explained

With the Verifier instrument, you have two measurement options which will determine the intelligibility of your building.

Speech Intelligibility Scale (STI)

The speech intelligibility scale is widely used nationally and referenced in the IEC- 60489 as a viable method to rate a mass notification system.

The scale identifies if the mass notification system is intelligible or unintelligible based on a **STI scale** ranging from 0.0 to 1.0 where **0.5 to 1.0** is considered a passing score, per NFPA 72 and IEC 60849.

STI	00 - 0.30	0.3 - 0.45	0.45 - 0.60	0.60 - 0.75	0.75 - 1.00
scale	Unacceptable	Poor	Fair	Good	Excellent

Figure 1-2: STI scale

Common Intelligibility Scale (CIS)

Another method to report intelligibility results is using the Common Intelligibility Scale (CIS) scale. It was created to map all methods (i.e., STI, percentage of articulation loss of consonants, word lists) to the same scale so that results could be compared.

Similar to the STI scale, the CIS scale uses a range from 0.0 to 1.0 to determine if the MNS is intelligible. However, with the **CIS scale**, a rating of **0.7 to 1.0** is an “intelligible” score, per the IEC 608489 and NFPA 72.

CIS	00-0.48	0.48 - 0.65	0.65 - 0.78	0.78 - 0.88	0.88 - 1.0
scale	Bad	Poor	Fair	Good	Excellent

Figure 1-3: CIS scale

Zones

“Where do I measure speech intelligibility?” Buildings, such as hotels, medical facilities, or stadiums can be broken into “zones”.

Each “zone” has a room with one alarm system. In some situations, one room may have more than one alarm system or may have a change in ceiling height (such as an atrium or balcony seating versus lower level seating). In those instances, each section would be considered a zone and each zone would be tested.

After determining the “zones” in your building, it is recommended to design a map of the key zones/rooms. Generally, a zone is a 20X20 area. If the room is larger than 20X20, it is recommended to take another measurement in this section.

When to take STI-PA measurements

Scenario one

You may be able to run the test signal through the PA system during normal business hours. In this scenario, you would set the meter to STI-PA and select either STI scale or CIS scale and run your study in the mapped “zone” areas.

Scenario two

In other situations, running a test tone through a PA system during business hours could be distracting and not feasible for your environment. In this situation, it is recommended to follow these procedures:

- **First**, take sample background noise measurements during business hours. These are saved and stored on the Verifier as “Captured Curves”. The verifier will save up to four “captured curves”
- **Second**, in the STI-PA options, select the appropriate captured curve.
- **Third**, run your measurements at the appropriate time of day (i.e., late evening/early morning). (The applied captured curve will automatically factor into your study.)
- **Fourth**, view your results on the display of the instrument (or in Excel by using the File converter tool.)

Getting Started

The key components of the Verifier include the microphone, preamplifier, graphics display, keypad, “AA” battery compartment, and the bottom connection panel. This chapter introduces you to the major components of the Verifier including: the equipment, understanding the keypad, turning on/off, powering the instrument, and hardware components.

Checking the equipment

If your instrument was sent to you in a storage case, you will want to remove all the packaging and acquaint yourself with the equipment, so you can quickly get started. The items below are included in a “standard” Verifier kit.



Figure 2-1: Verifier equipment

Microphone and accessories

The Verifier is shipped with either a Type/Class 1 or a Type/Class 2 microphone in a protective case with a serial number labeled on the side of the microphone. To attach and remove the microphone, please follow one of the types below:

- **BK4936 microphone (Class/Type 1)** - Remove the microphone from its case and thread it on the Verifier preamp in accordance with the instructions provided in the microphone case. *Note that the BK4936 microphone is provided with a Random Incidence Corrector (RIC). Use the same microphone instructions for information about using and installing that device.*
- **Class/Type 2 microphones** – Remove the microphone from its protective case and thread it on the preamp. Before using, be sure to remove plastic cap and save it in the case for future use.



- NOTE:** to properly remove the microphone, please adhere to the caution sticker located on the backside of the instrument and the drawing to the right.

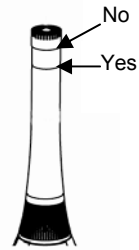

Windscreen

Use a windscreen that fits the tip of the microphone to reduce sound disturbances caused by physical contact and wind turbulence. Quest provides the WS-7 windscreen that fits a ½-inch microphone with the Verifier kit. Other optional sizes are available depending on the size of the microphone you ordered.

Attaching the preamp and microphone

The instrument's preamplifier (preamp) and microphone are detached and shipped in the carrying case.

► Connecting to the instrument



Figure 2-2: Verifier, preamp and microphone

1. **Attaching the preamp:** Place the preamp connector over the mating connector at the top of the instrument. Gently press down while rotating the preamp until the preamp connector drops slightly in place. While pressing the connector together to engage the threads, rotate the black knob clockwise to secure the preamp to the instrument. It will fit securely.
2. **Attaching the Class/Type 1 or Class/Type 2 microphone:** The instrument is shipped with the microphone detached. Remove the microphone from its protective case and thread it on the preamp. Before using, be sure to remove plastic cap.

☑ **NOTE:** *if removing the microphone from the preamp, please adhere to the caution sticker located on the backside of the instrument.*

Display and Keypad

Explained

The keypad is used to setup the instrument, run a study, stop a study, view your measurement values, and power on and off the instrument. Table 2-1 explains the function of the keypad and display features.

Indicators (Top line)



- Battery power: 
- Pause: 
- Run time: 00:00:15



Figure 2-3: Verifier keypad and display explained

Keypad	Explanation
1. Display	Used to view measurements (L _{AEG} , STI-PA results), range, menus, and various indicators.
2. Backlight	Used to illuminate the background of the display/screen. (i.e., nighttime study.)
3. Stop key	Used to stop your study when you are in pause mode. A 3,2,1 countdown will appear as you continue to press the stop key.
4. Up/Down arrow keys	Used to navigate through menus and/or data.
5. Run/Pause key	Used to run a study. At the end of the run, a pause indicator will appear. You can press run again to start another measurement or you can press stop to close the session. The run, pause, or stop indicators will appear at the top of the screen
6. Softkeys (Shortcut menus)	The softkeys are used for additional menu options and are accessible on a few of the Verifier's screens such as the Calibrate and File System screens.
7. Alt/f key	The <i>Alt/f</i> key (or Alternate functions key) is used to view, select, and apply the captured curve pop-up screen.
8. Enter key	Used frequently to execute an action. Typically used after you have first pressed one or more arrow keys to make a selection.
9. Left/ Right arrow keys	Used to navigate right through menus and/or data.
10. On/Off and Esc keys	Used to turn on, turn off, and to Escape (or move back one screen).

Table 2-1: Keypad Explained

Quick Start

Turning on

1. To turn on the Verifier, press the **On/Off/Esc**  key until the start screen appears.

Start screen

The Start screen is the first screen you see when you power on and the last screen you see when you shut down. For a quick up and running instrument, the Verifier welcomes you in the STI-PA measurement screen.

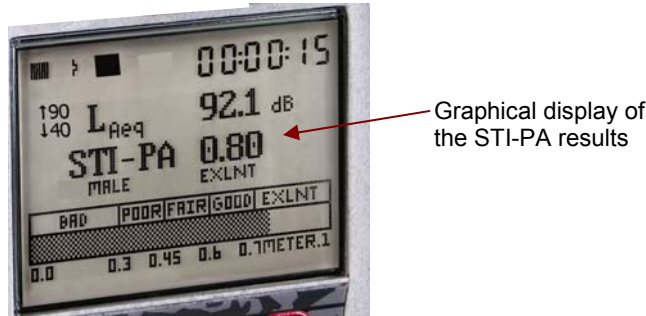





Figure 2-4: Verifier start screen

Navigating

With the Verifier, there are two measurement screens and one setup menu to navigate through. To select one of these screens or menus, press the **Right/Left**  keys.

The **Enter**  key is used to select parameters, move between setup columns, and will also toggle through some of the settings.

The **Up/Down** arrow  keys are primarily used to select setup parameters.

The **On/Off Esc**  key is also used as a navigational tool at any time you wish to move back one level. If you press **ESC** repeatedly you will return to the start screen.

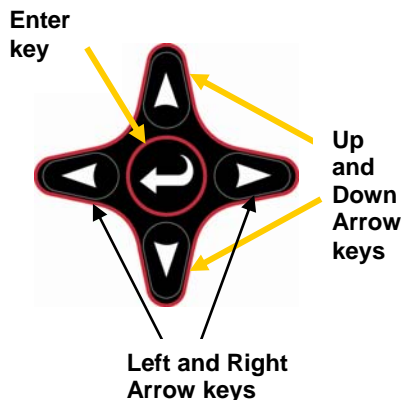



Figure 2-5: Arrows and enter keys on the keypad

Turning off

1. To turn off the Verifier, ensure the meter is stopped (i.e.,  indicator will display on the top of the screen).
2. Press and hold the **On/Off/Esc**  until the start screen disappears.

Screen indicators explained

Status information is provided by the instrument at the top of the display. Below is a summary of all of the indicators.







Icon	Significance
	Battery charge status. This icon shows the status/level of the batteries. The example shown to left indicates that the battery is at full capacity.
	Run state. This icon appears when a study is running.
	Paused state. This icon appears when the current session is open but paused.
	Stop state. This icon appears when the current session is stopped.
	Review mode. When the pause and stop icons appear, this indicates that you are viewing a saved file.
OL	Overload condition. When an overload occurs during a study, this indicator appears remains until the session is closed (or when you press stop). Once the instrument is stopped, the OL indicator becomes live. <ul style="list-style-type: none"> • An overload will occur whenever the input signal exceeds the dynamic range of the instrument.
UR	UnderRange condition. When an underrange condition occurs during a study, this indicator appears and remains lit until the beginning of the next study.
	Alternate functions. This icon appears below the Battery Charge Indicator when alternate functions are being displayed.

Table 2-2: Screen indicators

Providing power

You can power the instrument with internal batteries or from an external power source. There are two optional sources which include a universal power supply 9V/.66A 2.1 mm and an auto DC jack cable 12V. (See Optional Parts, in Appendix A for more details.)

Installing batteries

The instrument requires four AA-sized batteries. Disposable alkaline batteries are satisfactory, but you may also use rechargeable Nickel Metal Hydride (NiMH) batteries.

- **Rechargeable batteries** - The instrument does not contain a recharging circuit. Recharge batteries externally using the recharging device available from Quest or a compatible device available elsewhere.
- **Selecting batteries** - Do not mix battery types or batteries with significantly different charge levels.

☑ **NOTE:** To avoid possible battery leakage, remove the batteries when the instrument is not in use for prolonged periods.

► To install batteries

1. With the back of the instrument facing up, push the release latch to pop open the battery lid.

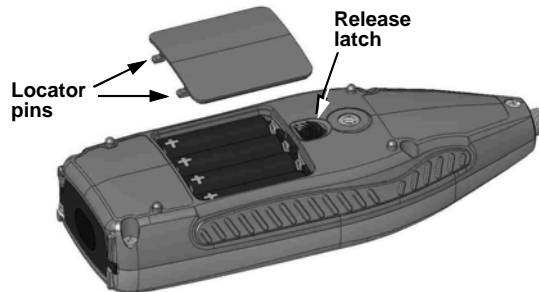

Figure 2-6: Installing batteries

2. Lift off the lid and set aside. Remove the four batteries.
3. Replace the batteries with fresh batteries, taking care that you orient all batteries with the positive ends toward the base, as shown in the drawing.
4. Re-insert the lid by fitting its locator pins into slots in the base end of the battery compartment. The lid should fit snugly when correctly inserted.
5. Press the top edge of the lid to snap it into the latch.
6. Verify or set the type in the Battery Check screen.

Battery power explained

The battery check screen displays the battery /power status of the instrument. When operating on batteries, the grey area in each cell graphic indicates the charge on each cell.

When operating on an external power source (see next section, “Power supply or adaptor”), the external power will take precedence over batteries if installed.

Battery indicator

If all bars appear up to starting line, this indicates full battery power

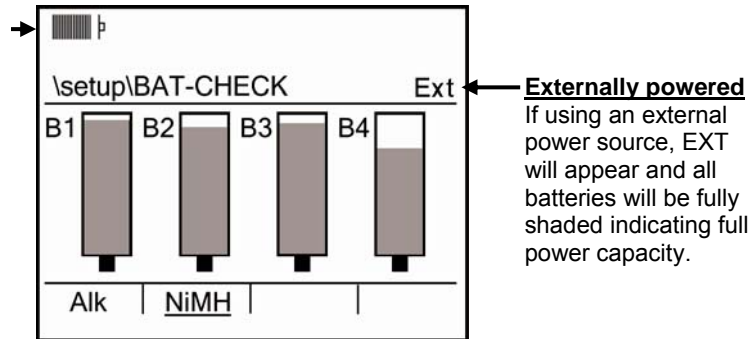



Figure 2-7: Battery check screen

Checking type

The Battery check screen is also used to ensure you have the appropriate battery type selected; otherwise you may experience an unexpected shutdown.

► Battery Check screen

1. Turn on the Verifier by pressing **On/Off/Esc**  key. You will be at the STI-PA measurement start screen.
2. To access the **Setup** menu, repeatedly press either the **Right/Left** arrow key until it appears.
3. Select the **Battery** menu by pressing **Up/Down** arrow key and press **Enter**  key.

- To change the battery type, press the softkey which corresponds to the batteries you inserted. The selected battery type is noted with an underline.
- Alkaline (See A below)
 - NiMH (See B below)

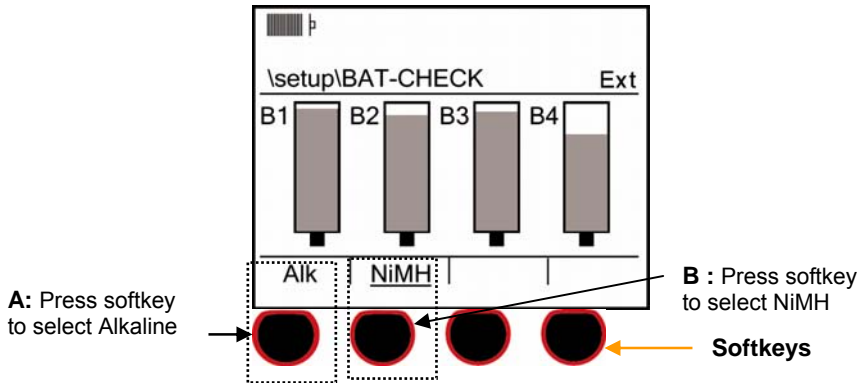

Figure 2-8: Selecting battery type in battery check screen

- When completed, press **On/Off/Esc**  twice to return to the STI-PA measurement /start screen.

Power supply or auto adapter

If you purchased the optional Universal power supply 9V cable or the Auto DC Jack 12 VDC adapter from Quest Technologies, plug them into their respective power sources and the other end into the Power jack of the instrument. If the external power source provides the correct voltage (8-16 VDC) and sufficient current (300 mA minimum), it will be used in place of the batteries if they're installed in the instrument.



Figure 2-9: Power supply adapter examples

Connector panel/ hardware

The connector panel or hardware Interface Panel is located under a hinged cover in the base of the instrument. The cover can be lifted by a tab at one side, and snapped shut again by closing and pressing the connector door firmly.

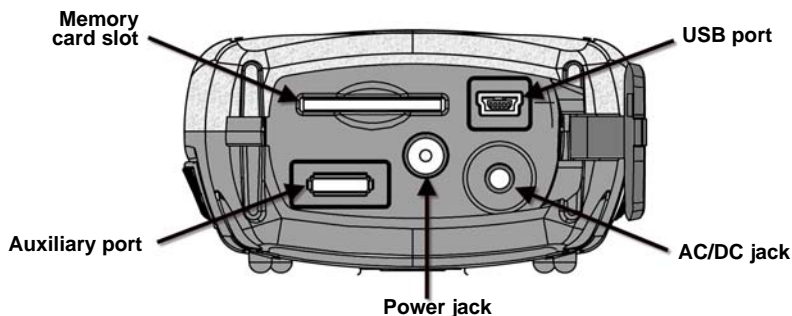

Figure 2-10: Connector panel

Memory card slot

A Secure Digital (SD) removable memory card is shipped with each Verifier instrument. The card should always be in place when you are operating the instrument.



NOTE: You must use a compatible SD card. For information about replacing the SD card or to format, please see “Memory Card” in Chapter 4.

USB port

A USB cable is shipped with each Verifier. One end fits the mini B port in the instrument. The other end fits a standard USB connector on a personal computer. A USB connection to a personal computer allows files to be transferred, settings to be downloaded to the instrument, and post-session analysis to be performed in the computer using data files created in the instrument.

AC/DC port

Not supported on the Verifier.

Power jack

DC power can be delivered to the instrument through the Power jack. Power will be taken from the external source rather than the instrument's batteries when the external source provides 8 to 16 volts DC (300ma minimum).

Two optional sources for this power are available: a switching power supply connected to an AC source and DC power provided through the accessory jack of most automobiles. Please refer to either the "Power sources" or see "Part numbers" in the Appendix for more information.

Auxiliary port

Use for GPS connectivity with serial cable P/N 053-729.

Setting-up the Verifier

This chapter covers the basic features and setups of the Verifier which include the following:

- Setting measurement parameters
- Setting time and date parameters
- Viewing battery charge and/or changing the battery type
- Setting up the display including language, backlight, and screen contrast
- Changing the microphone settings (Signal input screen)
- Unit Information parameters

Measures setup screen and capturing background noise

The measures setup screen is one of the main screens you will visit from time to time in order to select a STI-PA scale, select a gender voice, and/or select/apply a captured curve. (**NOTE: to change the range, visit the STI-PA screen which is the initial powered-on screen.**)

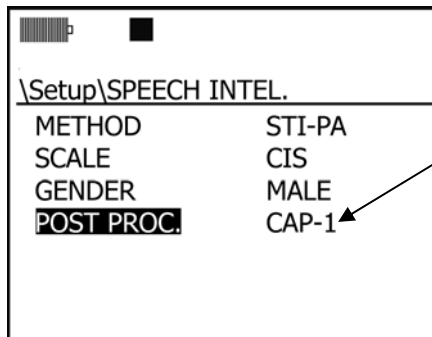

To measure the background noise during non-working hours, set the post-process field to Capture Curve (1-4), and then run a measurement.

Figure 3-1: Sample measures setup screen

The following table explains all of the parameters found in the measures setup screen.

Measures setup screen	Explanation
Scale type field	Select either STI scale or CIS scale. (Please refer to Chapter 1, “STI scale or CIS scale”)
Gender field	The voice can be set according to the test signal being use, male or female voice. NOTE: <i>the Verifier default setting is Male. If using the test signal supplied by Quest Technologies, this uses a male test signal; so, you will not have to change this field if you only use the male test tone signal.</i>
Post Process field	An optional “ captured curve ” feature can be applied to your STI-PA testing. Essentially, you take a snap shot of the current sound level measurement and store it as your background noise. Once the background noise data is gathered, you can apply the captured noise during your STI-PA measurement. This may be used in a situation where you cannot play the test signal during “normal” working hours. (Please refer to Chapter 1, “When to take STI-PA measurements, scenario 2” for more details.)

Table 3-1: Measures setup screen parameters explained

➤ **Opening the Measures setup screen**

1. Open the **Setup** screen.
 - From the STI-PA Measurement/Start screen, press the **Left Arrow** key.

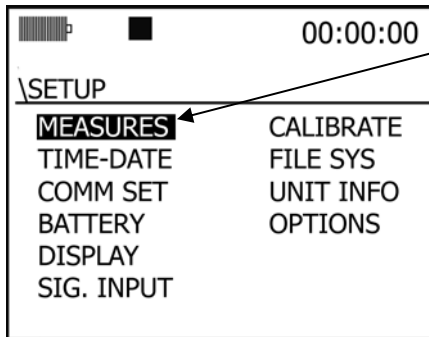

Setup screen
 “Measures” is selected.
 Press Enter key to open the menu.

Figure 3-1: Setup screen



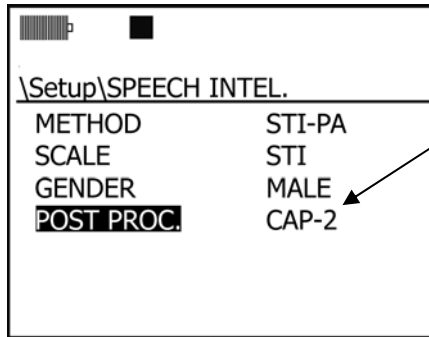

2. Select the **Measures** field and press **Enter**  key.

☑ **NOTE:** *the Measures field should be selected/shaded when you open this screen. If it isn't press the up or down arrow key to select and then press the **Enter** key.*

**Speech Intelligibility setup**

- **Method** - not a changeable field
- **Scale** - STI or CIS scale
- **Gender** – female or male voice
- **Post Proc** – optional method to save the current SPL (also called captured curve)

Figure 3-2: Speech intelligibility/measures setup screen

3. To change the **Scale** field, press the **Enter**  key to switch between **STI** or **CIS** scales.
4. To change the **Gender** field, press the **Down Arrow** to select the field and press **Enter**  key to switch between **Female** or **Male**.
5. To change the **Post Processing** field, press **▲▼ Arrows** to select. Then, repeatedly press the **Enter**  key until the appropriate captured curve is selected. (The default setting is “Off”).
6. To change the **Range** field, press **▲▼ Arrows** to select. Then, repeatedly press the **Enter**  key until the appropriate range is selected.
7. Once all parameters are selected, repeatedly press the **On/Off/Esc**  key to return to the STI-PA measurement screen.

Setting up time and date

The Verifier uses a 24-hour clock and specifies date by the month and year.

➤ Changing date and time settings

1. Open the **Setup** screen.
 - From the STI-PA Measurement/Start screen, press the **Left Arrow** key and the setup screen will appear. (See Figure 3-1).
2. Press **▲▼ Arrows** key and select **Time-Date**. Press **Enter** **↩** key to open the **Time-Date** settings screen.

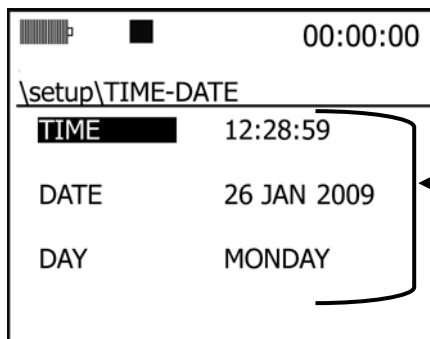

Time and Date fields

Change the Time/Date value fields by pressing up/down arrows. Press Enter key to move to each field.

Figure 3-3: Setting up time and date

3. To change the Time or Date fields, first select the fields by pressing **▲▼ Arrows**.
4. Press **Enter** **↩** key to move to the second column/changeable field.
5. To change the values, press **▲▼ Arrows**. To move to a subsequent field, press **Enter** **↩** key.
6. Repeat this process until all fields have been programmed/set.
7. To return to the STI-PA measurement/ Start screen, ensure the selection/highlighted text is in the 1st column. Then, repeatedly press **On/Off/Esc** **⏏** key.

Setting up the display (language, backlight, and contrast)

The display's backlighting, contrast and language characteristics can be customized to suit your needs and preferences. These settings can be viewed or changed in the Display screen.

- **Language:** There are six different languages to choose from which include: English, French, German, Spanish, Portuguese, and Italian. A change in language takes effect when you exit the Language screen.





- **Backlight:** The Verifier is shipped with the backlight feature set to "manual mode" which allows you to turn on/off by pressing the backlight key. The backlight feature has an optional timed setting for various second intervals ranging from 1 second to 60 seconds. Once a timed setting is activated and you press the backlight key, the backlight will illuminate for the selected interval (i.e., 10 seconds) and then turn off.

☑ **NOTE:** *Backlighting consumes energy at an increased rate. Leaving it on while operating with batteries will decrease battery life by up to 10%.*

- **Contrast:** The contrast adjustment affects all pixels in the LCD screen. The greater the contrast setting the darker the display will be (and vice versa).

☑ **NOTE:** *If the contrast level is set too high, icons and the RunTime clock in the Status Region of the display can be ghosted (visible in this display although they're not supposed to show). Reduce setting to avoid ghosting.*

➤ Changing the display settings (language, backlight, and contrast)

1. Open the **Setup** screen.
 - From the STI-PA Measurement/Start screen, press the **Left Arrow** key and the setup screen will appear. (See Figure 3-1 for Setup screen example).
2. Press **▲▼ Arrows** to highlight **Setup** and then press **Enter**  key.
3. Select **Display** by pressing **▲▼ Arrows** to highlight and then press **Enter**  key.

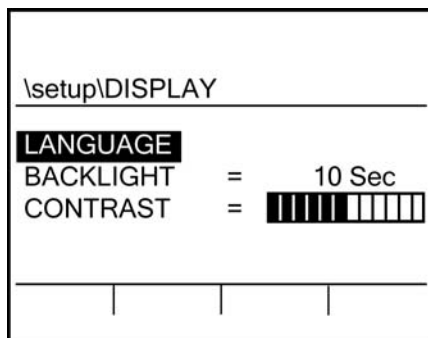



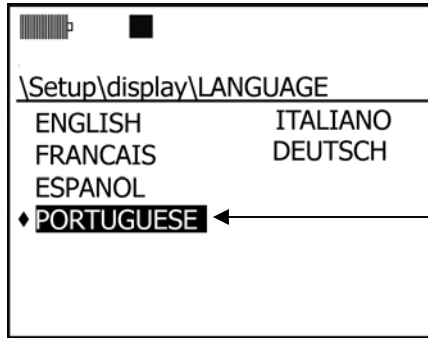

Figure 3-4: Display screen (language, backlight, and contrast)





4. To change the **Language** setting, ensure **Language** is highlighted (or press up/down arrow to select) and press **Enter**  key .
 - The Language screen appears. An asterisk (*) precedes the name of the currently selected language.
 - Press  **Arrows** to select.
 - Once selected, press **On/Off/Esc**  key to return to the display screen.



Language

Portuguese is the selected language in this example.

Figure 3-5: Language screen

5. To change the **Backlight**, select the field by pressing  **Arrows**.
 - Press **Enter**  key to select either Manual or a value (10 seconds is the default timed setting). If selecting a value press  **Arrows** until appropriate value is selected. When set, press the **Left Arrow**.
6. To change the **Contrast**, select the contrast field by pressing  **Arrows**.
 - Press the **Left or Right Arrows** to decrease/increase the contrast setting.
7. To return to the STI-PA measurement/ Start screen, press **On/Off/Esc**  key twice.

Changing microphone settings

With Class/Type 1 models, the microphone's sensitivity, range cap, and polarization can be checked and/or changed in the "**Signal Input**" menu (when stopped). Alternatively, Class/Type 2 models settings are viewable at any time the session is stopped but cannot be modified. The following table displays the required mic. settings.

Signal Input	BK4936	QE7052
Sensitivity ^a	-28.0	-29.0
Range Cap (dB)	140	140
Polarization (V)	0	0

Table 3-2: Required microphone settings

► Changing Microphone settings

This procedure applies only to Class/Type 1 models.

1. Open the **Setup** screen.
 - From the STI-PA Measurement/Start screen, press the **Left Arrow** key and the setup screen will appear. (See Figure 3-1).
2. In the Setup screen, select **Sig. Input**, then press **Enter** . The Signal Input screen appears.

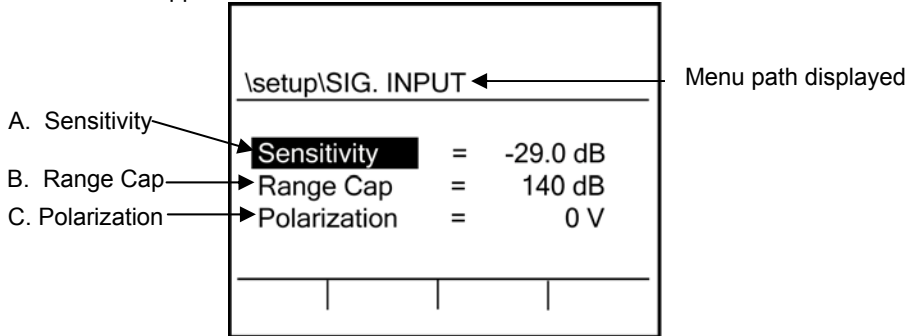





Figure 3-6: Microphone Settings (Signal Input screen)



3. Signal Input options are explained below.
 - A. **Sensitivity** ~ Calibration parameter for the selected microphone. This is a nominal value in decibels relative to 1V/Pa.
 - B. **Range Cap** ~ Top of the measurement range for the microphone/ instrument combination. In any screen showing a decibel range, this setting affects the maximum value. (**NOTE:** This field is not changeable unless using a Type 1 microphone. The standard setting is 140 dB.)
 - C. **Polarization** ~ A value of the polarization voltage for the microphone. Some microphones have an internal polarization, while others require a polarization provided by the instrument. (**NOTE:** this field is not changeable unless using a Type mic. The standard setting is 0 V).
4. To change a signal input field, press **▲▼ Arrows** to highlight specific field (s).
5. Press **Enter**  key. The result will be one of the following:
 - **For Sensitivity and Range Cap** fields - The highlighting moves to the data field. Press **▲▼ Arrows** to change the value.
 - **Polarization** field - Polarization remains highlighted. Continue to press **Enter**  key to change (or toggle) the value from 0 V to 200 V.
6. Once desired fields are changed, press **On/Off/ Esc**  key twice to return to the STI-PA Measurement/Start screen.

Unit Information screen

The unit information screen displays the microphone type (type 1/type 2), the serial

number, the revision number, and installed features (if they exist).

► **Opening unit info screen**

1. Open the **Setup** screen.
 - From the STI-PA Measurement/Start screen, press the **Left Arrow** key and the setup screen will appear. (See Figure 3-1).
2. Press  **Arrows** and select **Unit Info**.
3. Press **Enter**  key to open the **Unit Information** screen. The following fields will appear:
 - **Instrument field** – displays the Model and the Class/Type (1 or 2)
 - **Serial number field** - displays a unique serial number assigned when the instrument was manufactured.
 - **Revision field** – displays the latest firmware/software installed on the instrument.
 - **Installed features field** – displays any installed features.

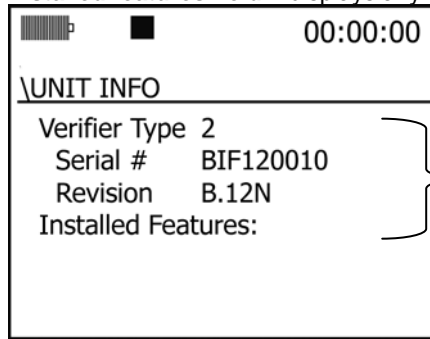

Information screen

Summary of the instrument's firmware and serial number.

Figure 3-7: Unit Information screen

4. To return to STI-PA /Start screen, press the **On/Off/Esc**  key twice.

Calibrating and Communication

This chapter focuses on how to calibrate the Verifier and also discusses how to communicate with the USB cable and an optional GPS device.

Calibrate

Quest Technologies recommends calibrating your Verifier before you run a STI-PA measurement and after to ensure highly accurate measurement results.

The microphone should be calibrated before use for a number of reasons. First, the microphone is sensitive to humidity and pressure changes. Calibrating before taking measurements assures that your level measurements are accurate for the current environment. Performing a calibration verification (post-cal) allows you to verify that conditions have not significantly affected your readings. Calibrating also serves the dual purpose of checking the microphone for significant damage, such as a torn or contaminated diaphragm.

You can calibrate the instrument in the field with reference to the output of a calibrated sound source. Quest offers a line of acoustic calibrators that are available (such as the QC10/20).

Calibration screen

The Calibration screen contains a calibration option, called **Calibrate**, and a Calibration History. The history shows Pre-Calibration (Pre-Cal) and Post-Calibration (Post-Cal) results for previous calibrations, as applicable. For each calibration type, the resulting SPL level is shown along with the time and the date of the calibration.

Pre-Calibration

The main reason to calibrate is to adjust the current microphone reading to match a reference input, usually provided by a calibrator.

A Pre-Calibration is conducted when the session is stopped. When you calibrate during a stopped session, the new calibration results replace the previous Pre-Calibration results and the Post-Calibration results are removed. You will always see the last Pre-Calibration results.

Post-Calibration

A post-cal is really a calibration verification; that is, it does not change the instrument's calibration. It compares the microphone's current level with the value read from the last calibration (assuming that the same source is used).

A Post-Calibration is a calibration done during a session pause. When you calibrate during a pause, the new calibration results replace the previous Post-Calibration results without affecting the Pre-Calibration results. You will not see Post-Calibration results if a pre-calibration was performed but not followed by a Post-Calibration.

Attaching the calibrator to the Verifier

Before beginning your calibration, ensure the calibrator has sufficient battery power to perform the calibration. Also, you will want to insert the "cal adapter" into the mouth of the calibrator.

If the Verifier has a windscreen, please remove this before calibrating (if applicable).

➤ **Calibrating**

1. Ensure the Verifier is turned **On** and is either stopped or paused.
2. Attach the calibrator and cal adapter to the Verifier. Set the calibrator to 1 KHz and 114 dB (if it is a selectable).



Figure 4-1: Attaching calibrator to the Verifier

3. From the display of the Verifier, navigate to the Set-up screen.

- From the STI-PA Measurement/Start screen, press **Left arrow** key to open the Set-up menu.
4. Select **Calibrate** by pressing **▲▼ Arrows**. Press **Enter**  key to open the Calibrate screen.
 5. Switch **On** the Calibrator.

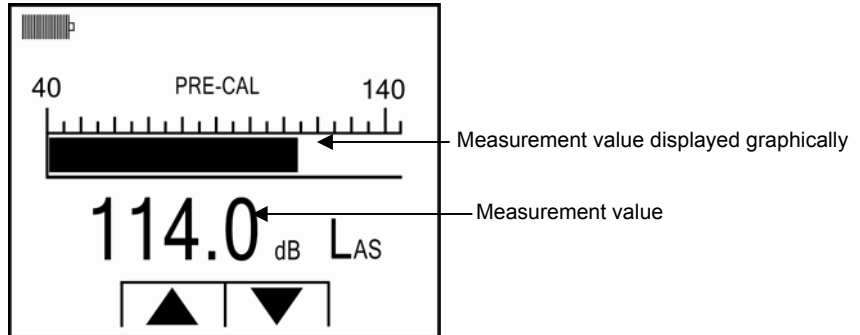



Figure 4-2: Calibrating the Verifier

6. Allow the measurement to stabilize and then press **▲▼ Arrows** to set 114.0 dB.
7. Press **Enter**  key to store the new calibration. The Calibration History screen will reappear with the new calibration values in the display.

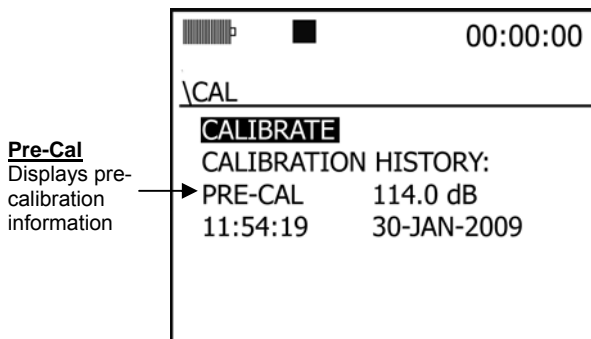

Figure 4-3: Pre-Calibrate history screen

8. Press **On/Off/Esc**  key to exit the Calibrate screen.

9. For a **Post Calibration**, ensure the Verifier is in “Pause” mode. (Essentially, run a measurement and it will pause after 15 seconds.) The Pause indicator will appear at the top of the display. Then repeat the Calibration steps above and press Enter to store the Post Calibration information. A sample screen is displayed below with post calibration history.

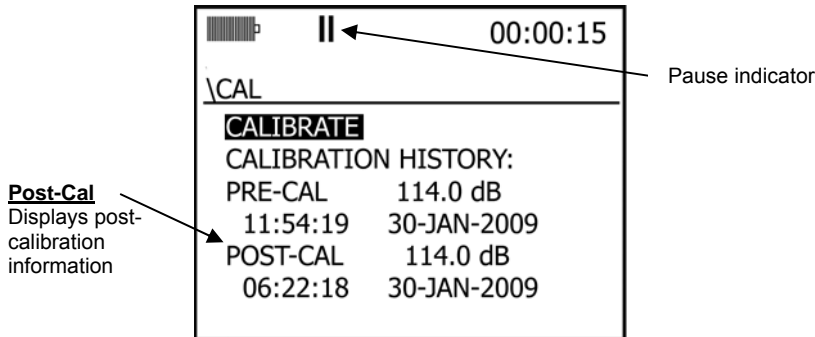

Figure 4-4: Post-Calibrate history screen

Communications

The Verifier has both USB and RS-232 communication channels. The majority of users should only require USB communications, which is vastly faster than the RS-232 channel which is intended for low speed modems and GPS applications, but may be used to communicate to a PC as well. The optional 053-729 Serial Cable is required for RS-232 communications.

The Verifier has two USB communications modes which are: QSP/II/Serial and Mass Storage.

- **QSP/II/Serial** (Figure 4-5 “A”). For QSP-II communications or other supporting applications, USB should be set to QSP/Serial. The RS-232 channel should be turned off for low power consumption.
- **Mass Storage** (Figure 4-5 “B”). When the USB channel is set for Mass Storage mode the user will have direct access to the instruments SD card through programs such as “Windows file manager”. Much the same way a small pocket USB flash drive operates. When obtaining data from the Verifier via Mass Storage, it is important to remember that the data obtained is in Native Verifier SES format. A File Converter Tool is available to enable you to export the data into Excel. (Please see “File Converter Tool” for more information.)

NOTE: When using Mass storage, the user must use the Windows “Safely Remove Hardware” feature to un-mount the Verifier from the PC in the same manner a user must remove a flash drive.

This “Windows” feature is usually found in the lower right-hand side of the windows systems tray.

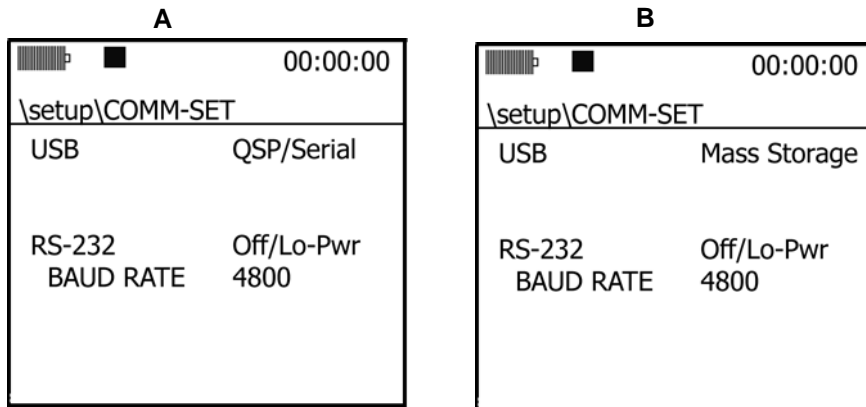

Figure 4-5: QSPII/Serial (A) and Mass Storage(B) screens

USB communications

➤ USB communications

1. If a session is running, stop it.
2. In the Setup screen, press **Arrows** to select **Comm Set**, then press .
3. USB should be Highlighted. Press to toggle between **QSP/Serial** and **Mass Storage**.
4. If the RS-232 channel is not set to **Off/Lo-Pwr**, press the left arrow to highlight RS-232 and repeatedly press until Off/Lo-Pwr is displayed.
6. Press to exit the screen.
7. Connect the USB cable to the Verifier and then to the USB connector on the computer (see “USB port” for more details, on page 15).

GPS

The Verifier has the capability of embedding GPS information into study headers. To interface a GPS, you need a GPS receiver with RS-232 communications that conform to NMEA 0183 version 2 and the optional 053-729 Serial Cable. In many cases, a Male-Male DB-9 null modem connector will be required as well.

The Verifier will keep a GPS fix for up to 1 minute before declaring it invalid at which time “No Fix” will appear if you are in the “COMM-SET” menu.

NOTE: GPS time can be viewed in the Comm Set screen but is not otherwise used in the instrument.

GPS display

You can view GPS data in the Comm-Set screen. The position coordinates are stored in each study which GPS is enabled.

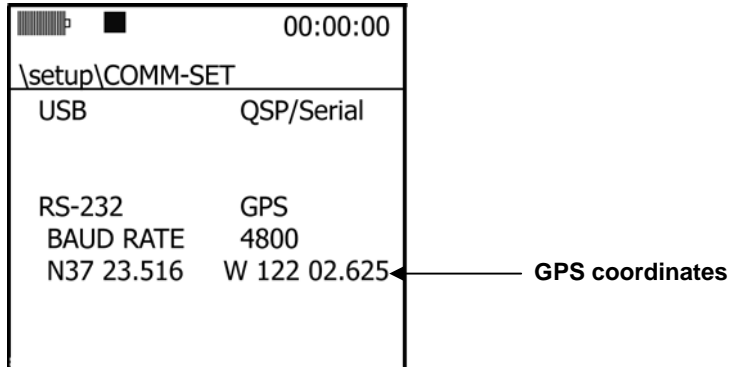

Figure 4-6: GPS data



GPS explained

The top two screen selections, Interface and Baud Rate, specify the GPS setup, which is explained under “Enabling GPS communications,” below. The rest of the information in the screen appears when GPS communications is enabled and data is being received from a GPS satellite.

- **Status line** - This data field at the right on this line tells you whether GPS is enabled or not. You may see “No Fix” below this line, which tells you that, although enabled, the instrument is not receiving the satellite signal.
- **Position line** - When the satellite signal is being received, there will be two data fields on this line that give the instrument’s latitude (N or S) and longitude (E or W) position in degrees and minutes.
- **Other line** - When the satellite signal is being received, there will be two data fields on this line that give the instrument’s altitude and time, in that order. The altitude is given in meters above mean sea level. The time is given for Greenwich, England (GMT) and differs in hours from your time by the number of time zones between your location and Greenwich.

➤ Enabling GPS communications

1. If a session is running, stop it.
2. Connect the RS-232 cable to the GPS receiver and to the auxiliary port of the Verifier.

3. Referring to the user manual for the GPS receiver, prepare the device to receive satellite signals.
4. In the Verifier Setup screen, press the arrow keys to select **Comm-Set**, then press , and the Comm-Set screen appears.
5. Press the down arrow to highlight "RS-232".
6. Repeatedly press  until "GPS" is displayed. The Baud rate should be kept at 4800 unless otherwise specified by your GPS manufacturer.

⚠ NOTES: *If you are not using RS-232 communications in any way, you should keep the RS-232 channel set to the Off/Lo-Pwr setting.*

This page left blank intentionally

Measuring and reviewing results

Guideline to setting up a STI-PA test

1. Calibrate the Verifier.
2. Set-up your STI-PA options via the "Measures" setup screen.
3. A level setup is conducted. From a fixed-point, the technician measures the A-weighted SPL of MNS message (or alarm system) and adjusts the range as needed. The test signal volume should approximately match the MNS message volume. Adjust the test signal to match the L_{AS} value as needed.
4. The test signal is played through buildings voice system (PA system).
5. The technician/sound tester positions himself/herself in "zones"/building areas.
 - It is recommended to design a map of "zones"(or rooms) to indicate where you will be taking your measurements.
 - Set measuring range appropriately.
6. STI-PA measurement is conducted. Press the Run/Pause key to start the study.
 - ✔ **NOTE:** If you want to measure background noise prior to the STI-PA testing, first "capture curves" (or background noise) and then apply this during your study. (See "Captured Curves".) After a 15 second countdown, either a STI or CIS level is displayed with a pass/fail message.
7. The technician/sound tester moves throughout the building and measures in all zones/rooms.
 - ✔ **NOTE:** A zone/room is typically a room 20x20. More than one measurement may be required if the room exceeds this size.
8. The tests are noted as pass/fail. (NOTE: the past tests can be reviewed and loaded via the File System screen.)

The figure below depicts obstacles that mask the quality of the speech path when conducting a Speech Intelligibility measurement.

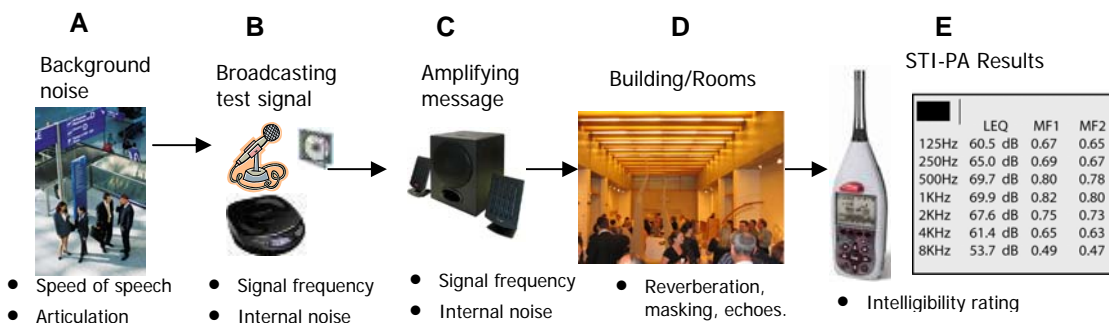

About STI-PA measurements & modulation screen results

The test signal is derived from 7 octave band signals that encompasses a combination of vowels and syllables from common speech. There are 14 modulating frequencies that emulate a male/female's speech patterns. The STI method is based on the determination of the modulation transfer function (MTF) which is the ratio of measured modulation to the overall signal strength at each modulation frequency.

In the **STI-PA measurement screen**, the MTF is combined according to IEC 60268-16 and presented on a scale between 0 to 1 representing the quality or intelligibility of the mass notification system.

In the **Modulation measurement screen**, the average decibel level over the run-time in seven octave bands ranging from 125HZ to 8KHz with 14 frequencies is displayed in a tabular format. These values are the test signal to noise ratio in each attenuation band and indicates which values are intelligible/unintelligible based on the CIS/STI scale.

Table 5-1 defines the STI-PA: modulation frequencies for the seven octave bands (per the IEC 60268-16 standard).

Octave band Hz	125-250	500	1 k	2 k	4 k	8 k
First modulation frequency Hz	1.00	.63	2.00	1.25	0.80	2.50
Second modulation frequency Hz	5.00	3.15	10.0	6.25	4.00	12.5

Table 5-2 defines the STI octave band with specific male and female weighting factors used with STI-PA measurements (per the IEC 60268-16 standard).

Octave band Hz	125-250	500	1 k	2 k	4 k	8 k
Males	0.127	0.230	0.233	0.309	0.224	0.173
	0.078	0.065	0.011	0.047	0.095	-
Females	0.117	0.223	0.216	0.328	0.250	0.194
	0.099	0.066	0.062	0.025	0.076	-

Conducting a level setup

- From a fixed-point, measure the A-weighted Sound Pressure Level of your mass notification system (or alarm system).

- The average dB level is displayed when in stop mode.

☑ **NOTE:** *the instrument will display the L_{AS} when in stop mode. This is also called “survey mode”.*



Figure 5-1: Level set-up and average decibel level

Preparing to measure

Before you begin measuring, there are a couple items to consider:

- Understanding sessions and studies
- Adjusting the measurement range before running a study (Please refer to the Measures setup screen on page see 17 for details.)

The following table explains how the data is stored on the instrument.

Storing Data	Explanations
Session	<p>A session is comprised of one or more studies and uses data derived or accumulated from those studies to arrive at session results.</p> <p>With the Verifier, you may want to organize your data into sessions when you are taking measurements in various zones. If, for example, you want to take 3 STI-PA measurements within one zone, you could store all of this data as a session by pressing Run/Pause, Run/Pause, Run/Pause and then pressing Stop. The data in the one zone will now be considered “studies” within the one “session”.</p>
Studies	<p>Studies are periods in a session during which measurements are acquired, processed and saved by the instrument. The duration of each study period is called the study’s run time.</p>

Table 5-3: Sessions and studies explained

☑ **Caution:** *The memory card should not be inserted or removed during a study—you can lose data.*

Running a speech intelligibility study

Before proceeding with a STI-PA measurement, ensure you calibrated the Verifier and conducted a Sound Level setup.

NOTE: *if there is impulsive noise present, it is best to capture the background noise (via the Captured Curve pop-menu), remove the noise, or come back later when the noise is not present. That is because impulsive noise and strong voices can skew the measurement results. If you captured the background noise, you would then come back when the noise is not present and apply the captured curve during a STI-PA measurement. (See Captured Curves for more information.)*

The following instructions explain how to run, pause, and stop a STI-PA study without captured curves. (If you wish to take a background noise sample, also called “captured curves”, please refer to Captured Curves on page 38).

NOTE: *it is optional to organize your measurements into sessions and studies.*

▶ Running a STI-PA study

1. The Verifier should be **powered on** and you should be viewing the **STI-PA measurement screen**.
2. **Play the signal** over the loudspeaker and then locate yourself in the appropriate **zone/room**.
3. Verify that the range setting is appropriate for the level being measured. (It is desirable to select the longest range that does not overload.)
 - To change the range, press Up/Down Arrow keys when in the STI-PA screen.
4. Press the **Run**  key to begin your study.
5. The instrument will **run for 15 seconds** and then pause.
 - To continue to take measurements, repeat step 3.
 - To terminate your study, please see step 6.

6. Press the **Stop**  key to end your study. Figure 5-2 displays a sample STI-PA results screen.

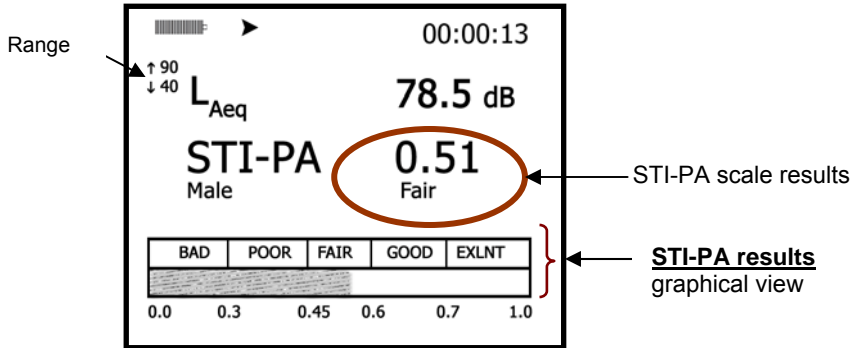

Figure 5-2: STI-PA results screen

7. To view the modulation screen, press the **Right Arrow** key.

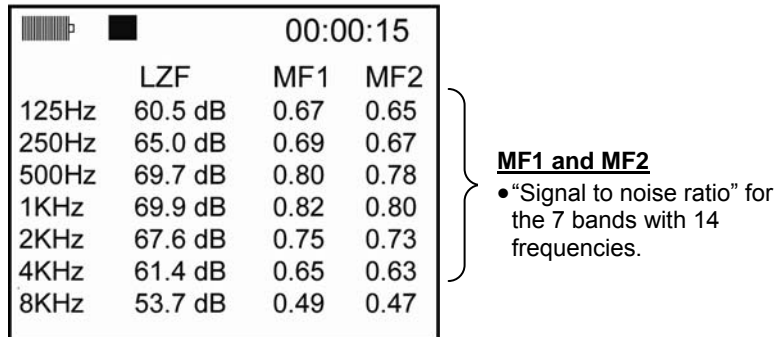

Figure 5-3: Modulation screen with STI-PA results

Modulation Frequency Column note

“MF1” and “MF2” values represent the signal (also referred to test signal) to noise ratio (accounts for any interfering background noise such as non-linear distortions, electronics, reverberation, HVAC systems) for each band, ranging between 0.00 to 1.00. These values are calculated to determine the overall STI score (displayed on the STI-PA screen).

Captured Curves (storing background noise)

Capturing a curve allows you to take a snapshot of the current octave noise profile. It is used to store up to 4 different sound level values during “normal” operational work shifts without being disruptive with the STI-PA test signal. Once stored/“captured”, the background level/noise is later applied while running the STI-PA test tone through the building’s public address system. The Verifier will automatically calculate the captured curve results with the STI-PA measurement results.

► Capturing a curve

1. Navigate to the modulation screen (displayed in Figure 5-4) via the right/left arrow keys. (*NOTE: you may want to be in the stop mode to view the fluctuating sound level values. If in Pause, you will not see the screen update.*)
2. Press the **Alt** key. A Captured Curve pop-up screen will appear (see figure below.)

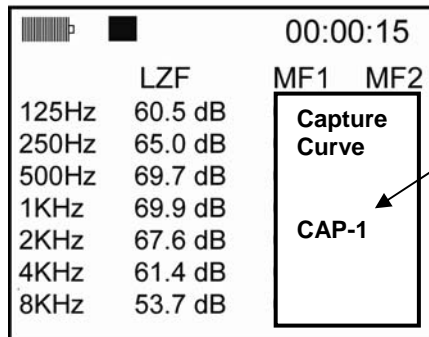

Capture Curve

- Press up/down arrows to change and press enter to apply the current **Average dB level**.





Figure 5-4: Saving capture curve/background noise

3. Press **▲▼ Arrows** to select Cap-1, Cap-2, Cap-3, or Cap-4. (**Note:** for your first capture, you may wish to leave the default of Cap-1, thus skipping this step.)
4. Press **Enter** to store the current levels and exit the pop-up/selector screen.
 - NOTE:** once you select a capture curve and press the Enter key, the Verifier will automatically store the average decibel reading.

Applying captured curves (background noise)

Once you have captured curves/background noise, these will store in the memory of the Verifier. To apply the curves/background noise during a STI-PA measurement, first select the curve through the Measures setup screen in the Post Processing field and select Cap-1, Cap-2, Cap-3, or Cap-4. Then return to the STI-PA measurement screen (or the modulation screen) and run your measurement with the test signal. The Verifier will automatically apply the curve results/background noise in your study.

➤ **Applying Captured curves**

1. In the Setup screen, select **Measures** and press .
2. Select the **Post Processing** field (by pressing  **Arrows** .
3. To change the setting to either **Cap-1, Cap-2, Cap-3, or Cap-4**, repeatedly press  key until the desired curve is selected.

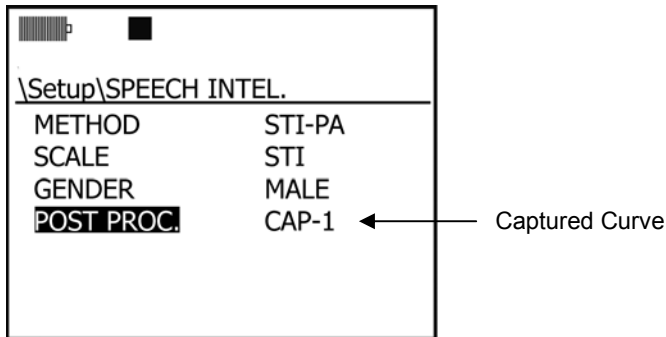



Figure 5-5: Selecting a captured curve

4. Return to the STI-PA Measurement/Start screen by repeatedly pressing **On/Off/Esc**  key (or press left/arrow keys to toggle through the screens).
 5. Press the **Run/Stop** key while playing the test signal in the appropriate location/zone. In the STI-PA measurement screen, it will display “post cap-x” (where x represents captured curve 1, 2, 3, or 4.)
- NOTE: press the left/right arrow to view the modulation screen if desired.*

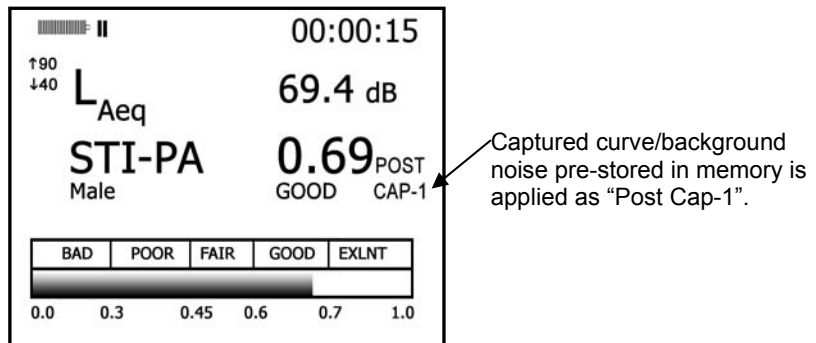

Figure 5-6: STI-PA with cap. curve/background noise applied

Reviewing Results

File directories



Files on the memory card are stored in directories. Session files are automatically stored in the Session Directory, and Configuration Files are automatically stored in the Configuration Directory. Use the file directories to load files, to delete files, and to inspect filenames as part of a naming or renaming procedure to determine if a filename has already been used.



CAUTION: *The memory card should not be inserted or removed when working in the instrument's file system – you can lose data.*

File Directory screen explained

In the file directory screen, you can select a past session to load and view on the instrument's display. Additional menu/screen options are available including: configuration directory, renaming a session file, saving a configuration file, and formatting the card are all performed in this menu structure.

1. From the **Setup** screen, select the **File Sys.** and press .
2. In the File screen, select **Session Directory** or **Configuration Directory**, then press . The directory that you requested appears.

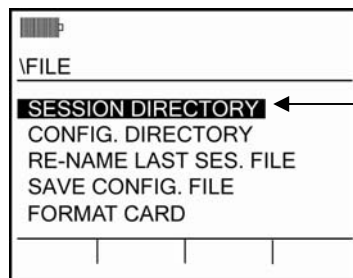

Select Session Directory to past measurements and then press Load

Figure 5-7: File Directory Screen

Differences between directories

The **Session Directory** screen (see “A” below) and the **Configuration Directory** screen (see “B” below) are both types of directories.

NOTE: The Path Lines are different, and generally the filenames are different as well. In all files associated with the Session Directory, the Path Line will read “Data File.” In all files associated with the Configuration Directory, the Path Line will read “Setup File.”

(A) Session Directory

\DATA FILE	
S001	S006
S002	S007
S003	S008
S004	S009
S005	S010

DELETE | | LOAD | MORE..

(B) Configuration Directory

\SETUP FILE	
CCONFIG	
VERIFIER	
SND_TE2	
SND_TE3	

DELETE | | LOAD | MORE..



Figure 5-8: Examples of directory screens

Loading and deleting files

The loading of files enables you to review past measurement results. At any time, you can delete sessions as well.

☑ **NOTE:** It is important to understand that the delete operation takes place as soon as you press the respective softkey. While you can re-load a file, you cannot un-delete a file, so be cautious.

➤ Loading or deleting a file

1. In the Setup screen, select **File Sys** and press .
2. Select **Session Directory** and press .
3. Select a file by pressing  Arrows.
4. To **load a file**, press the **Load** softkey.

- To **delete a file**, press ▲▼ to select appropriate file and press **Delete** softkey. (The display will state the file was deleted.) Press ↶ key to return to the Data File screen. To delete additional files, repeat this step. Press ↶ repeatedly to return to the measurement screen.

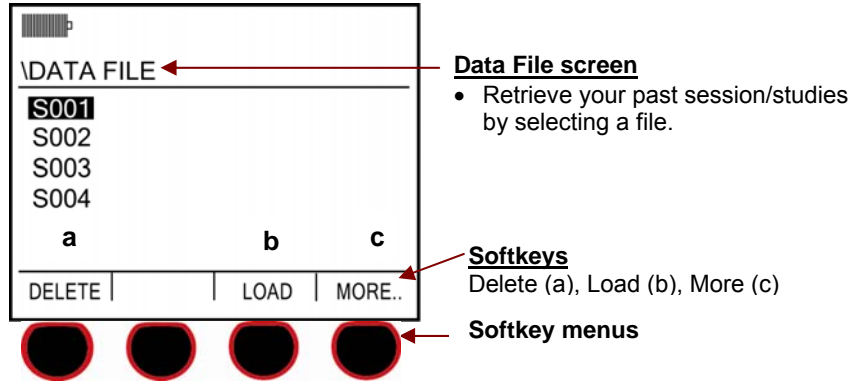

Figure 5-9: Loading and deleting files

☑ **NOTE:** You may have dozens of files saved. Press the **More** softkey to expand the file list for the appropriate selection.

- If you loaded a file, please see next section, “Viewing Past Measurements”.

Viewing past measurements

Completed studies and sessions, called past studies and sessions, are stored on the instrument’s memory card. You can view past measurements by first retrieving the study or session. The results will be played back in accordance with the analysis type that was selected when the measurements were made.

➤ Viewing a past session

- Load the session from the memory card (see section above “Loading and deleting files”).
- Once loaded, press ↶ key and the STI-PA measurement screen will appear.
 - ☑ **NOTE:** The run and pause indicators will appear on the top of the screen identifying the measurement results as a “past session”.
- To view either the STI-PA measurement results or the modulation measurement results, press the left or the right arrow.
- When you are ready to exit the past session mode, press the **Stop** key.
- To view additional past sessions, please repeat steps 1-4.

Memory card

The memory card supplied with the instrument is used to store session and configuration files. If you run studies and sessions without a memory card, it will not store session files. Once you press stop to close the session, the information is lost. Essentially, lack of a memory card converts a multi-session instrument into a single session instrument.

Compatibility

Steps have been taken to make sure the Verifier is compatible with as many SD cards as possible. Because of the many SD card manufacturers and the varying low-level formats they use, Quest Technologies can only guarantee operation with cards available from Quest Technologies. If you use a card not supplied by Quest, it should be no larger than 2 GB and have a FAT16 format. We recommend those manufactured by SanDisk. SDHC cards are not supported.

➤ **Determining the format of an SD card**

1. Insert the card in the computer's card reader drive.
2. Open Windows Explorer.
3. Right-click on the CD drive listed under My Computer.
4. From the right-click menu, select Properties.
5. On the General Tab, the File System field identifies the card's format.

Formatting card

The Verifier has the capability of doing a **Quick Format** or **Full Format**. A **Quick Format** is all that is required in most cases to format a card in FAT 16 format. A **Full Format** will verify each sector of the card as it formats with the penalty of taking much longer.

 **CAUTION:** A **Quick Format** may be used to delete all files from the card.

Naming and renaming files

There are common procedures that you can use to name and rename files, including a lookup capability that allows you to determine if a filename is already in use.

Renaming session files

You cannot rename a session file unless it is in the instrument's memory. Accordingly, you can rename the closed session currently residing in memory, but you must first load a past session file before you can rename it.

➤ **Renaming the session in memory**

1. In the File System setup screen, press  to select **Re-Name Last Ses. File**.

2. Press  key.
3. The session file renaming screen appears.
4. Follow the instructions under “Naming/renaming config files” below.

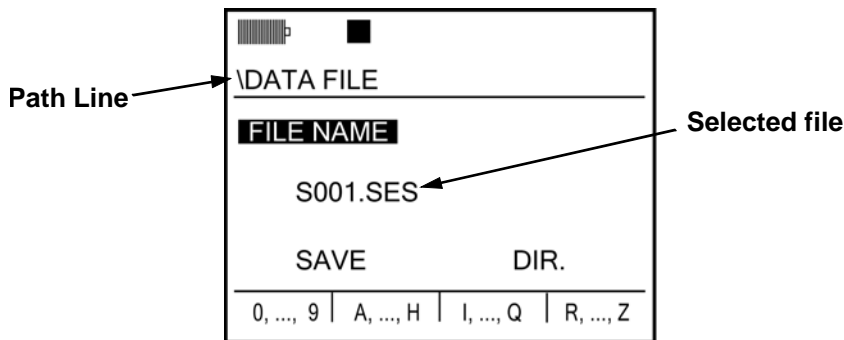

Figure 5-10: Viewing Files

➤ **Renaming past session files**

1. Load the session (See Loading and Deleting Files”).
2. Follow the instructions under “Renaming the session in memory”, above.



Naming/renaming config. files







The naming/renaming procedure below includes a lookup utility that you can use to determine what name to assign.

Naming

Use the procedure in this section to name either a session or a configuration file, depending upon the sequence you followed to get to this point.

➤ **Naming/renaming procedure**

1. In the File Name screen, press  and the following changes will occur:
 - The highlighted cursor moves to the field of one of the four softkeys, depending upon the last character in the existing filename.
 - The last character in the filename is underlined.
2. To view the existing filenames in the directory before selecting a name, (called a “name lookup”) do the following:
 - Press  to exit the softkey label field. **Save** is selected.
 - Press the right arrow key. **Dir.** is selected.
 - Press . The directory opens.



- When finished checking names in the directory, press  to return to the renaming screen.
 - Press any arrow key to select **File Name**. Press on/off esc key. Select Rename Last Ses. File. (See next step to return).
3. Take the following actions to change the underlined character.
 - Press  to move sequentially through the characters for that softkey. The underlined character in the name changes as you press the keys.
 - Press a different softkey to select a different character set.
 - Add a character by pressing the right arrow key.
 - Delete a character by pressing the left arrow key.
 - 4 Repeat the operations in the previous step as many times as necessary to compose the name.
 5. When finished, press . The **Save** selection in the screen is highlighted.
 6. Press  and a message appears telling you whether the renaming is successful or not.
 - **Successful** - If the filename is unique, "File Saved" appears. Press  to exit the renaming screen.
 - **Unsuccessful** -If the filename is already in the directory, "File Error - File Already Exists" appears. Press  to return to the renaming screen.

Configuration file

Use the procedure below to create a configuration file from the current settings in the instrument. Naming a configuration file is an integral part of this saving procedure.

Creating

➤ **Creating the file**

1. If the session is open, you must stop it before you can make configuration changes or save a configuration file.
2. Change or verify the parameter and instrument settings that you prefer according to procedures explained elsewhere in this manual.
3. In the File System setup menu, select **Save Config. File** by pressing .
4. Press . A naming screen appears for configuration files. The configuration file naming screen is identical to the screen shown in Figure 5-9 except the Path Line reads \Setup File and the selected file has a "cfg" extension.
5. Follow the procedure given under "Naming" to name and save the file.

Viewing results in Excel and file converter tool

For easy data analysis and report creation, the “SES file Translator” (part number: 057-882) is a program that will export (or download) your Verifier study files (called SES files) into Microsoft Excel (XLS) format. The following sections will walk you through downloading the SES file translator program and then take you through exporting your files from your Verifier to Excel or XML files.

Downloading the SES file Translator

A quick install of the SES file Translator is required before you convert your Verifier files to Excel format. Please follow the steps below.

1. Launch the setup.exe file for the SES file translator.
2. SES Translator Install Shield Wizard will appear. Select **Next**.
 - Click **Install** to load the SLS translator. (The utility will load in about 20 – 30 seconds.)
3. Click **Finish** to conclude the install.

Exporting from the Verifier to your PC

1. While the Verifier is in the “On” mode, press **▲▼ Arrows** to select **Setup** from the main start screen.
2. Repeatedly press **▼** arrow to highlight **Comm Setup**. Press **↻** to select **Comm Setup**.
 - USB will be highlighted.
3. Press **↻** until **Mass Storage** is displayed on the Comm Setup screen.
4. An explorer window should appear on your pc with a **Data** folder.

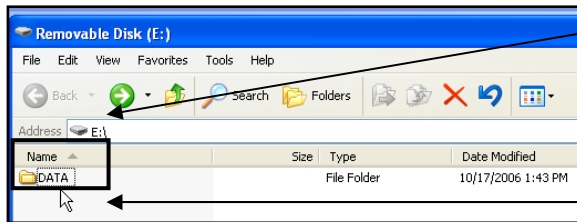

Address bar

Indicates file drive you are currently viewing

Data Folder

Right-click on DATA and select Copy

Figure 5-11: Example of explorer pop-up window with SES files

- **Alternative method:** Right-click on **Start** (bottom of your pc) and select **Explore**. Select your removable disk drive and **Data** folder should be displayed. (The example above displays “E” drive; however, your pc may map to a different drive depending on your pc configuration. You will want to look through your drives for “Data” folder).
5. To copy this folder (highly recommended), right-click on **Data** and select **Copy**. Paste this folder on a local or network drive.
 - *How to Paste on local/network drive?* Using the address bar (see figure 1-1 above), click on the drop down arrow and select a local or network drive. Either create a new folder or paste it in an existing folder.
 6. Once it is copied, double-click on **Data** folder.

7. Double-click on the SES file you wish to export to Excel or XML (see Figure 5-12).

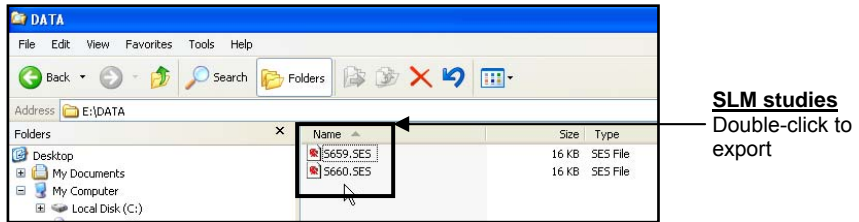

Figure 5-12: example of sound level meter studies.

- **Note:** if you want to export all of the files, click on the first file then follow step 8. When the first study runs, return to step seven and follow step 8. Continue through this process until you have viewed all of your studies.
8. A SES Translator dialogue box will appear.
 9. To export to an **Excel File**, select **Run!**.

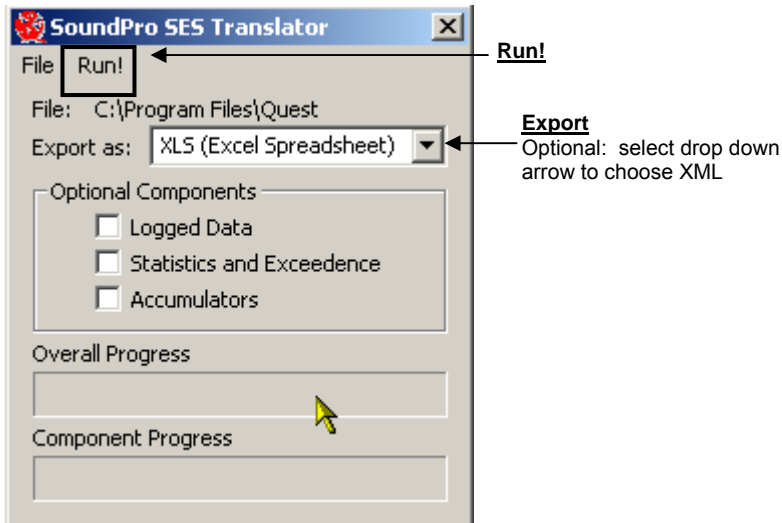

Figure 5-13: Verifier SES Translator Export dialogue box

- In Figure 5-14, it displays Verifier measurement data exported to Excel. The summary data is shown on the first worksheet and each study is shown in subsequent sheets (See Figure 5-15 as an example).

Verifier											
Serial Number			BIF030010			UNIT REV			R12N		
Microphone Information					Calibration Information						
Description	Units	Value			Description	Units	Value				
Sensitivity	dB	29			Pre-Cal	Level	dB	114			
Polarization	Volts	0				Date	09:44:56 21-Jan-2009				
Meter Range	dB	120			Post-Cal	Level	dB				
Max Level	dB	140				Date					
Meas. Floor	dB	-20			ReCert	Date	Unavailable				
Configuration Information											
Description	Units	Meter 1	Meter 2								
Integration Threshold	dB	OFF	OFF								
Exchange Rate	dB	3	3								
Criterion Level	dB	85	85								
Upper Limit Level	dB	115	115								
Projected Time	Hrs	8	8								
Weighting		Z	A								
Time Response		SLOW	SLOW								
Speech Intelligibility Settings											
Description	Units	Value									
Method		STI-PA									
Score		STI-PA									
Gender		Male									
Post Process		OFF									

Figure 5-14: Example session summary data in Excel

Study #	Date	Time	Duration	STI-PA	STI-CIS	LeqAS	LeqZS				
Study 1	11-Feb-2009	08:42:53	00:00:15	0.77	0.89	103	110				
Study 2	11-Feb-2009	08:43:36	00:00:15	0.79	0.9	102.9	109.9				
Study 3	11-Feb-2009	08:43:57	00:00:15	0.81	0.91	103	109.8				
Modulation Table											
125Hz			250Hz			500Hz			1kHz		
LeqZS	mf(0)	mf(1)	LeqZS	mf(0)	mf(1)	LeqZS	mf(0)	mf(1)	LeqZS	mf(0)	mf(1)
105.9	1.04	0.71	106	1.01	1.05	102.1	0.87	1.03	96.1	1.05	1.08
105.9	1.02	0.72	105.7	1.04	1.03	102.1	1.02	1.02	96.1	0.99	1.01
105.6	1.05	1.01	105.7	1.03	1.01	102.2	1.01	1.02	96.2	1.01	1.04
2kHz			4kHz			8kHz					
LeqZS	mf(0)	mf(1)	LeqZS	mf(0)	mf(1)	LeqZS	mf(0)	mf(1)			
90.1	0.95	1	84	0.98	1.04	77.4	0.96	1.01			
90.1	1.02	1.01	84	1.02	1.05	77.4	1.01	1.03			
90	0.99	1	83.9	1.09	0.98	77.4	1.02	1.02			

Figure 5-15: Example study data in Excel

10. Before disconnecting the Verifier from your PC, click on your tool tray (located on the Windows task bar, lower-right hand corner of your screen) .
11. Click on “**Safely remove hardware**” icon  and select “**Safely remove USB Mass Storage device**”.
 - This causes Windows to finish with partially written data on the card. (Note: you will want to follow the “Safely Remove” procedure on all USB flash drives.)

Specifications

Conformance to standards

Acoustics

IEC 60268-16 (2003); Objective rating of Speech Intelligibility by Speech Transmission Index

EMC emissions and immunity

Pending testing on production products.

References

Air temperature: 23 °C
Static pressure: 101,325 kPa
Relative humidity: 50%
Level: 114 dB
Frequency: 1 kHz
Microphone Capacitance: 18 pf
Microphone Sensitivity: -28 dB
Range: 110 dB
Angle: 0 Degrees

Mechanical characteristics

Housing - Stainless fiber-filled ABS/polycarbonate with internal EMC shielding.

Size - 7.9 cm wide x 28.2 cm long x 4.1 cm thick (3.1" x 11.1" x 1.6"). The width is measured across the face of the instrument. The length, which includes the preamplifier but not the microphone, is measured along the longest axis of the instrument.

Weight - 0.54 kg (1.2 lbs), including batteries.

Tripod mount - Threaded insert on the back of the instrument. Accepts a 1/4"-20 screw.

Electrical characteristics

While the instrument is operating from battery or external power it conforms to all applicable tolerance limits of the stated standards. While operating on battery power alone the instrument will automatically shut down when the battery power is depleted. The total battery voltage range is between the maximum overcharge voltage of the NiMH cells 6.6 volts and the low voltage automatic shut down voltage of 4.4 volts.

Power sources

Internal power

Approximately 8 hours of continuous operation at normal mode of operation under reference environmental conditions when full capacity batteries are installed.

Main batteries - Four, replaceable alkaline AA batteries included as original equipment. Rechargeable NiMH batteries available as an option.

- **Battery life (Constant run without backlighting)** - Varies depending on whether alkaline or NiMH batteries are in use. You can expect the longest battery life when using rechargeable 2700 mAH (or greater) cells.
- **Battery life (Constant run with backlighting)** - Will reduce battery life by approximately 10%.

Auxiliary battery

Internal battery protects against loss of settings when the main batteries are being replaced.

External power

External DC power may be provided to the Power jack from the AC or DC sources identified below. Power consumption will range from 1.0-1.5 W at 8-16 VDC.

- **8 VDC** - 125 to 190 mA
- **12 VDC** - 85 to 125 mA
- **16 VDC** - 60 to 90 mA

AC power source ~ Optional switching-type power supply, Quest part number 053-571.

- **Supply input** - 100-240V, 47-63 Hz
- **Supply output** - 9VDC, 1.1A max
- **DC connector** - Cable has 2.1mm plug (center pin positive)

- **AC adapters** - Included are different snap-on adapters that allow it to plug into various outlets.

DC power source - Quest offers a cable as an option that plugs into an automobile auxiliary jack, Quest part number 053-870. 9.0 Volts is the nominal power supply voltage to be applied to the DC power jack.

Preamplifier (removable)

Microphone - Accepts 13.2 mm (0.52") microphone directly. Other sizes require an adapter.

Input impedance - Greater than 1 G Ω ; less than 2 pF.

Signal limit - 11 VAC maximum.

Cable attachment - Capable of driving up to a 15M cable with negligible signal loss.

Meters

Input impedance - 20 k Ω in series with 11 μ F capacitance, with 100 pF capacitance to ground.

Bandwidth

The following bandwidth is typical for the instrument and preamp when set to the 40-140 dB range and F-weighting. Electrical signals are input to the system with the 059-703 input adapter installed on the preamp.

- **0.1 dB down** - 20 Hz to 14 kHz
- **1.0 dB down** - 5 Hz to 25.2 kHz
- **3.0 dB down** - 3 Hz to 25.8 kHz

Octave filters

Number of bands - Seven bands, with center frequencies (f_c) ranging from 125 Hz to 8 kHz. The octave filters are flat within < 0.3 dB in each passband. The half-power points are at 0.707 f_c and 1.414 f_c .

Octave skirts - With respect to f_c :

- **$f_c/2$ frequencies** - Approximately 20 dB down
- **$2f_c$ frequencies** - Approximately 30 dB down
- **$f_c/10$ frequencies** - Approximately 70 dB down
- **$10f_c$ frequencies** - Approximately 95 dB down

Instrument noise

Noise floor depends upon which microphone is being used. The following measurements are for a typical instrument, with the 059-703 adapter (18 pF) connected to the preamp and shorted at the BNC end. This condition closely simulates the noise floor of a 1/2-inch microphone. For these measurements,

the instrument was set to the lowest range and to a slow response time.

- 22 dBA
- 30 dBC
- 35 dBZ
- 40 dBF

Environmental effects

The typical time interval needed to stabilize after changes in environmental conditions is 5 minutes for each 10 °C change.

Temperature

Operating - Less than ± 0.5 dB effect over -10 °C to 50 °C (14 °F to 122 °F)

Storage - 25 °C to 70 °C (-13 °F to 158 °F)

Humidity

10% to 90% RH (non condensing)

User interface

Display

Size - 128 x 64 pixel display that measures 6 cm x 4.8 cm (2.4" x 1.9").

Lighting ~ Transflective to take advantage of ambient lighting plus fiber optic backlighting that can be manually operated or set to turn off after a timed interval.

Keypad

Construction - Molded layer that holds fourteen press-sensitive buttons.

Buttons - Five buttons have dedicated control functions, another five are primarily used for selection and navigation, and another four provide variable functions when they are defined in the display (softkeys). Languages English, Spanish, German, French, Italian and Portuguese.

Input/output

Memory card - Removable Secure Digital (SD) data storage device that is inserted in a slot at the base of the instrument. Stores measurements made in studies and sessions in session files. If the instrument has a logging option

installed and is logging measurements, the logged values are stored in the applicable session file as well. The card also stores configuration files.

Microphones

The following specifications apply to microphones connected to the instrument.

QE7052 - Free-field, Class/Type 2, (standard), low cost ½-inch diameter (.52"), electrets (200 volts must be set to "Off")

BK4936 - Free-field, Class/Type 1, (standard) ½-inch diameter (.52"), electrets (200 volts must be set to "Off")

Characteristic	BK4936	QE7052
Accuracy	Class 1	Class 2
Polarization	Electret	Electret
Diameter (inches)	½	½
Response characteristic	Free- Field	Free- Field
Frequency response (± 2 dB)	8 Hz to 20 kHz	20 Hz to 17 kHz
Sensitivity (dBV)	-28	-29
Sensitivity (mV)	40	35
dB noise (1 kHz third-octave band)	0	0
dBA noise	22	22
dBC noise	31	31
dBZ noise	35	35
dB F noise	40	40
Mic range dBA min. (recommended)	27	27
dB Peak	142	143
Nominal capacitance (pF)	12	15
Part number	059-523	056-317

Communications ports

Auxiliary - RS-232 communication.

USB - Mini USB connector. This port is used for data and file transfers between the instrument and a personal computer.

Measurements

Types

SPL measures – SPL (L_{AS}), Average value (L_{Aeq})

STI-PA/CIS – Intelligibility scale.

Ranges

Eight selectable ranges of 50 dB each. Ranges include: 70-20 dB, 80 – 30 dB, 90 – 40 dB, 100 – 50 dB, 110 – 60 dB, 120 – 70 dB, 130 – 80 dB, 140 – 90 dB.

Measurement parameters

Response time – Fast and Slow

Frequency weighting – A and F (flat)

Calibration

Pre-calibration - When performed, valid prior to the start of a session.

Post-calibration - When performed, valid for the previous study in the session.

Storage - All calibrations for a session are stored in the related session file.

Calibrators - All Quest Calibrators have an output of 114dB at 1 kHz, and some may have other settings. See “Calibrating and Communications” in Chapter 4 for more details.

Studies and sessions

Run-time clock - Duration of every run and session shown in screens as well as added to the session file.

Manual operation - Run, Pause and Stop keys.

Part numbers

Replacement parts

Part Number	Description
059-523	Class 1 BK4936 microphone ½" free-field electret (prepolarized)
056-317	Class 2 QE7052 microphone ½" free-field electret (prepolarized)
053-700	Standard preamp for SoundPro SE/DL/Verifier
017-524	SD card.
053-575	USB cable to pc for SoundPro SE/DL/Verifier
WS-7	Wrist strap, 1/4" - 20.
059-344	Windscreen for 0.5" microphone. Package of 3.
053-571	9V Switching-type, universal power supply.
QC-10	QC-10 Calibrator; 114dB at 1000 Hz Output.
QC-20	QC-20 Calibrator; Selectable 94dB or 114dB at 250 Hz or 1000 Hz Output.
056-990	1/2 inch Microphone-to-calibrator adapter for QC-10 and QC- 20 calibrators.
059-045	TP-1 tripod (height range: 18.5 in. - 48.9 in.).
053-851	Preamp extension cable, 1 M for SoundPro SE/DL/Verifier
053-852	Preamp extension cable, 3 M for SoundPro SE/DL/Verifier
053-853	Preamp extension cable, 15 M for SoundPro SE/DL/Verifier
053-870	Automobile cable for SoundPro SE/DL/Verifier
016-127	Direct-coupled input adapter.
059-703	Input adapter with 18 pF capacitor.
053-711	Carrying case for SoundPro SE/DL/Verifier
053-731	STI-PA test signal CD
053-734	STI-PA test source (Sony MP3 Playback CD walkman)

Port pinouts

Auxiliary connector

The auxiliary connector in the base of the instrument can be used to receive GPS signals or for RS-232 serial communications. The image below shows the pinout for the auxiliary connector.

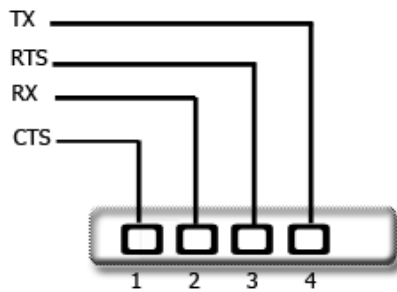

Glossary of Terms

CIS scale

The **Common Intelligibility Scale** (CIS) scale is used in a Speech Intelligibility test, cited by the IEC 608489 and the NFPA-72 standards, which uses a range from 0.0 to 1.0 to determine if a mass notification system is intelligible. A rating of **0.7 to 1.0** is considered a passing score.

dB

Sound Level Meters use the decibel as the unit of measure known as Sound Pressure Level (SPL). SPL uses the ratio between a reference level of 20 microPascals (.00002 Pascals) and the level being measured.

$$\text{SPL} = 20 \log (\text{measured level}/\text{reference level})$$

Example: the SPL for 1 Pascal is $20 \log (1 \text{ Pascal}/.00002 \text{ Pascal}) = 94 \text{ dB}$ 20 microPascals (.00002 Pascals) is considered the average threshold of hearing.

A whisper is about 20 dB. A normal conversation is typically from 60 to 70 dB, and a noisy factory from 90 to 100 dB. Loud thunder is approximately 110 dB, and 120 dB borders on the threshold of pain.

MTF

The **Modulation Transfer Function** is the ratio of the amount of modulation detected over the average signal level for each modulation frequency.

STI scale

The **Speech Intelligibility scale** (STI) is a range of measurement, widely used nationally and referenced in the IEC 60489 standard, which uses a scale from 0.0 to 1.0 where **0.5 to 1.0** is considered a passing score for a mass notification system.

STI-PA

Speech Intelligibility index - Public Address (STI-PA) system is an instrumentation method used to measure if a mass notification system (MNS) is clear, precise, and audible or intelligible.

Dynamic range

The range of input amplitudes on any given range setting over which the instrument can produce a meaningful response. The bottom of the dynamic range is the instrument's Noise Floor for that range setting, and the top of the dynamic range is the maximum input signal that will not overload the instrument on that range setting.

Exchange Rate (ER)

Also known as the Doubling Rate, this refers to how the sound energy is averaged over time. Using the decibel scale, every time the sound energy doubles, the measured level increases by 3 dB. This is the 3 dB Exchange Rate that most of the world uses. For every increase of 3 dB in the time weighted average, the measured dose would double.

Level (L_{FT})

Notation used to represent sound pressure level measurements in IEC/ISO notation, where the measurements are made with particular frequency (F) and time (T) response parameters. For an actual measurement, the F and T parameters are replaced by standardized notation for those parameters.

L_{AV}

Average sound level measured over the run time. This becomes a bit confusing when thresholds are used. Any sound below the threshold is not included in this average. Remember that sound is measured in the logarithmic scale of decibels therefore the average can not be computed by simply adding the levels and dividing by the number of samples. When averaging decibels, short durations of high levels can significantly contribute to the average level.

Example: Assume the threshold is set to 80 dB and the Exchange Rate is 5 dB (the settings of OSHA's Hearing Conservation Amendment). Consider taking a one hour noise measurement in an office where the A- weighted sound level was typically between 50 dB and 70 dB. If the sound level never exceeded the 80 dB threshold during the one hour period, then the L_{AVG} would not indicate a reading of zero. If 80 dB was exceeded for only a few seconds due to a telephone ringing near the instrument, then only those seconds will contribute to the L_{AVG} resulting in a level perhaps around 40 dB (notably lower than the actual levels in the environment).

$$L_{avg} = ER \left[\log_2 \int_0^{RTIME} 2^{LS/ER} dt - \log_2 (RTIME) \right] dB$$

L_{Aeq}

The true equivalent sound level measured over the run time. The term L_{Aeq} is functionally the same as L_{AV} except that it is only used when the Exchange Rate is set to 3 dB and the threshold is set to none.

L_{AS}

Sound pressure level – is the basic measure of noise loudness, expressed in decibels.

Modulation Frequency (MF1/MF2)

The modulation frequency (MF1/MF2) values are calculated numbers based on the modulation signal (test signal) and any interfering noise (auditory spectrum). The results of the 14 frequency values range between 0 to 1 indicating intelligible/unintelligible based on a CIS/STI scale. (Please see xxx for more information.)

Octave band

An Octave band is defined as a frequency band whose upper band-edge frequency is twice the lower band frequency.

Noise

Unwanted sound.

Noise Floor

The signal magnitude at the bottom of the instrument's linear range. Input signals below the noise floor cannot be differentiated from the internal noise of the instrument.

Overload (OL)

An overload will occur whenever the input signal exceeds the dynamic range of the instrument.

Pascal (Pa)

Unit of pressure equal to 1 Newton per square meter.

Reference pressure

The sound pressure at the threshold of human hearing, as measured under standard conditions. This generally accepted magnitude of this pressure is 2×10^{-5} Pascals (Pa).

Response time (F,S)

Selectable time response settings used in Verifier SE/DL measurements. The response time is a standardized exponential time weighting of the input signal according to fast (F) or slow (S) time response relationships. Time response can be described with a time constant. The time constants for fast, slow and impulse responses are 0.125 s and 1.0 s respectively.

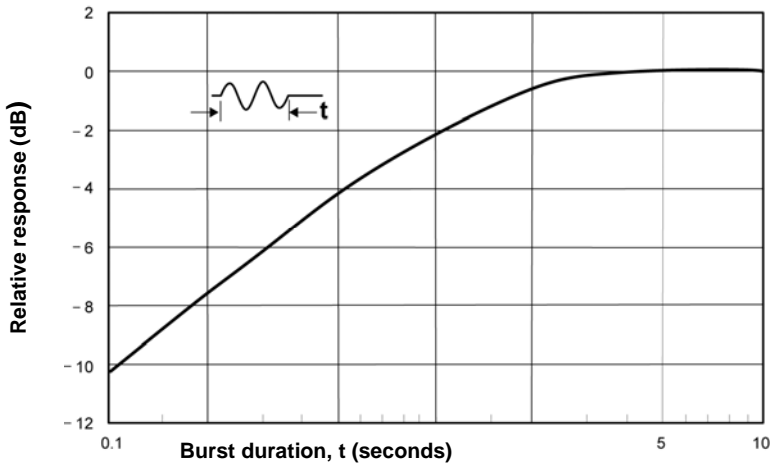

Figure B-2: Slow response to a tone burst

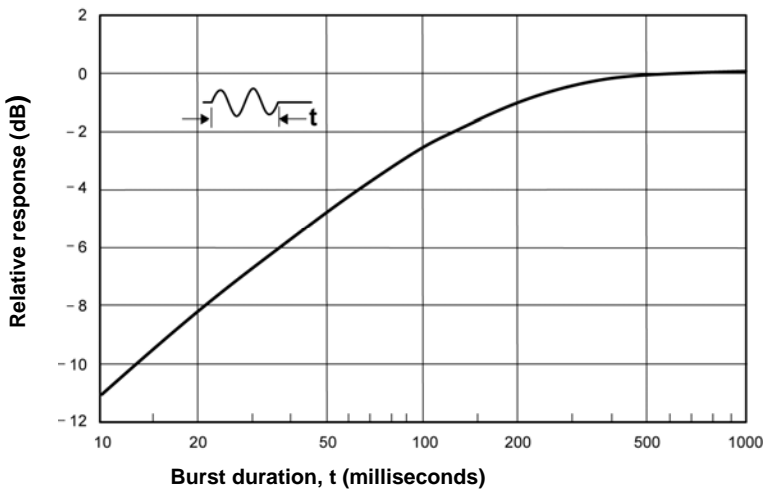

Figure B-3: Fast response to a tone burst

SPL

Sound pressure level. A ratio of one sound pressure to a reference pressure. Because of the enormous dynamic range of the human ear, the ratio is calculated logarithmically by the formula below, where L_r is the reference pressure.

$$\text{SPL} = 20 \log \left(\frac{L}{L_r} \right) \text{ dB}$$

Weighting (A, C, Z, F)

SPL measurements are commonly weighted (scaled) in relation to their frequency components in order to provide a consistent basis for comparison to other measurements of the same type. The four weighting curves are plotted together in Figure B-4, where the F-weighting curve has been shifted up by 5 dB for graphical clarity. The tolerance limits for F frequency weighting are the same as A, C, and Z frequency weighting.

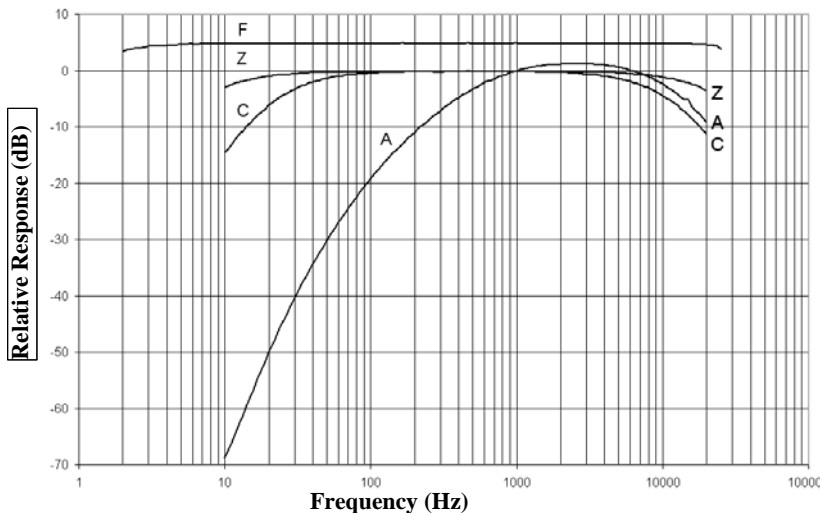

Figure B-4: All frequency weightings plotted together

Windscreen

A covering for a microphone that reduces disturbances caused by wind and direct contact with other surfaces.

Customer service

Contacting Quest

If you have questions about the Verifier's characteristics or operation or if you believe that it needs to be serviced, please contact Quest Technologies for assistance.

Telephone: +1 262 567-9157 or 800-245-0779 within the U.S.A.

- **Fax:** +1 262 567-4047
- **Internet:** www.quest-technologies.com
- **E-mail:** quest.mail@mmm.com

Before contacting Quest for assistance, become familiar with the SoundPro Information screen that contains the serial number of the instrument and other information that might be useful in resolving difficulties ("Unit Information screen" on page 23). If your instrument won't power up, the serial number is on a back label.

NOTE: *The Verifier and Quest field calibrator devices should be examined regularly by the factory. Quest recommends annual calibration.*

Service policy

Congratulations! You have purchased one of the finest instruments available, manufactured by one of the most respected names in safety & industrial hygiene instrumentation. Your instrument is backed by a limited warranty that seeks complete customer satisfaction. Should your instrument require service for any reason, you can expect prompt and courteous attention.

You must obtain a return authorization prior to shipment. We reserve the right to refuse any shipments forwarded without prior authorization.

The following information will expedite the service process and is required when obtaining return authorization:

- Model and serial number of each instrument.
- Description of work required and symptoms of any failures for each instrument.
- For non-warranty service only—VISA, MasterCard or American Express credit card or company purchase order number.
- Billing and/or return shipping addresses.

Use one of the methods below to obtain return authorization, service pricing and shipping instructions.

International customers

Contact your local, factory-authorized distributor from whom the product was purchased. You can obtain the name and contact information of your local factory-authorized distributor from Quest by using the e-mail, telephone or fax information given under **“Contacting Quest”** above.

United States customers

- Go to the Quest website at www.quest-technologies.com and look for the service section.
- Contact Quest via e-mail at sales@quest-technologies.com.
- Contact Quest at (800) 245-0779. Office hours are 8:00 a.m. to 5:00 p.m. United States Central Time.

Warranty

Quest Technologies warrants our instruments to be free from defects in materials and workmanship for one year under normal conditions of use and service. For United States customers, we will replace or repair (our option) defective instruments at no charge, excluding batteries, abuse, misuse, alterations, physical damage, or instruments previously repaired by other than Quest Technologies. Microphones, sensors, printers, and chart recorders may have shorter or longer warranty periods. This warranty states our total obligation in place of any other warranties expressed or implied. Our warranty does not include any liability or obligation directly resulting from any defective instrument or product or any associated damages, injuries, or property loss, including loss of use or measurement data.

For warranty outside the United States, a minimum of one year warranty applies subject to the same limitation and exceptions as above with service provided or arranged through the authorized Quest distributor or our Quest European Service Laboratory. Foreign purchasers should contact the local Quest authorized sales agent for detail.

INDEX

Alternate functions	
Indicator.....	11
Alt.....	9
Applying Captured curves.....	39
Attaching calibrator to the Verifier.....	26
Average SPL	
Defined.....	60
Background noise (see captured curves) ...	38
Backlight.....	9
Programming.....	21
Batteries	
checking or changing.....	13
Indicator.....	11
Battery check screen.....	13
Calibrating.....	25
Calibrating the Verifier	
Screen.....	27
Captured curves	
Selecting.....	38
Capturing curves.....	38
CIS scale	
Explained.....	3
Class/Type 2 microphones	
About.....	6
Conducting a level setup.....	35
Connector panel.....	15
Contacting Quest.....	64
Contrast	
Setting up.....	21
dB	
Defined.....	59
Display.....	9
Dynamic range	
Defined.....	59
Enter.....	9
Example session summary data in Excel ...	49
Example study data in Excel.....	49
Exchange Rate (ER)	
Defined.....	60
Exporting from the Verifier to your PC.....	47
GPS	
About.....	29
Explained.....	30
Setting.....	30
GPS display.....	30
Information screen	
Installed features.....	16
Installing batteries.....	12
Keypad	
Definitions.....	9
Keypad and Display	
Explained.....	8
L _{EQ}	
Defined.....	60
Language	
Setting up.....	21
Level (L _{FT})	
Defined.....	60
Loading and deleting files.....	42
Mass notification system	
about.....	1
Testing MNS & site factors.....	1
Mass Storage.....	28
Measurements	
STI-PA testing.....	2
Measures setup screen.....	19
Gender field.....	18
Post Process field.....	18
Memory card.....	43
Memory card.....	15
Formatting.....	43
Microphone	
Changing set up.....	23
Installing.....	6
Microphone settings.....	22
Naming	
Config files.....	44
Navigating.....	10
Noise	
Defined.....	61
Noise floor	
Defined.....	61
Octave band	
Defined.....	61
Overload	
Indicator.....	11
Overload (OL)	
Defined.....	61
Pascal (Pa)	
Defined.....	61
Pause	
Indicator.....	11
Post-calibrate history screen.....	28
Post-calibration.....	26
Power jack.....	16
Power supply adapter.....	14

INDEX

Power the instrument.....	12
Preamp and microphone	
Attaching.....	7
Preamplifier	
Installation	7
Pre-calibrate history screen	27
QSPII/Serial (communications).....	28
QSPII/Serial and mass storage screens	29
Reference pressure	
Defined	61
Renaming session files	43
Response time (F,S, I)	
Defined	62
Review	
Indicator.....	11
Run	
Indicator.....	11
Running a speech intelligibility study	36
Screen Indicators	11
Screens	
Battery check.....	13
Session/config directories.....	41
Selecting battery type	14
Session	
explained	35
Setup screen	
Contrast	21
Example.....	18
Language.....	22
Setup screens	
Microphone/signal input	23
Softkey menu	9
Specifications.....	51
Speech intelligibility	
Factors	2
When to take	4
Zones	4
Speech transmission index	
Explained.....	2
SPL	
Defined	63
Start screen	10
STI scale	
Explained.....	3
STI-PA	
Running a study	36
STI-PA results	
Modulation screen	37
STI-PA results screen.....	37
Stop	9
Indicator.....	11
Studies	
Explained.....	35
Time and date	
Setting up	20
Turning off.....	11
Turning on.....	9
Underrange	
Indicator.....	11
USB cable	15
USB communications	29
Verifier equipment.....	5
Viewing a past session	42
Viewing results in Excel	46
Weighting (A, C, Z, F)	
Defined	63
Windscreen.....	6
Defined	63